

**SOUND TECHNOLOGY
MODEL 1700B
DISTORTION MEASUREMENT
SYSTEM**

**SOUND TECHNOLOGY
1400 Dell Avenue
Campbell, CA 95008
Tel: (408) 378-6540
Telex: 357445**

*S-T Model 1700 Series U. S. Patents:
3940715, 3978401, 4032857*

Manual Part Number: 7900-0001
Manual printed in U.S.A.
Copyright July 1979

www.stancurtis.com

www.stancurtis.com

WARRANTY

All new Sound Technology products are warranted against defects in materials and workmanship for two years from the date of delivery. Any instrument or component that is found to be defective within the warranty period after examination by Sound Technology or an authorized representative thereof will be repaired or replaced without charge for labor or material. No other warranty is expressed or implied. We are not liable for consequential damages.

Before returning a product to Sound Technology for service, authorization must be obtained from the factory. For products not covered by the warranty, a purchase order should be forwarded to avoid unnecessary delay. Please include instrument model number and serial number with all requests for parts or service to facilitate the fastest possible response.

All products returned to the factory must be shipped prepaid. For products under warranty, Sound Technology will pay for shipment back to the customer.



**SOUND
TECHNOLOGY**

MANUAL CHANGES

CHANGE SECTION 5 - PARTS LISTS - AS FOLLOWS:

1. Page 5-1, Parts List: AC receptacle (P/N: 3110-0000) replaced by Line Filter (P/N: 3110-0005).
2. Page 5-2, Parts List, Oscillator: R40 same as R8 (P/N: 1100-0051). R34 now 392K, 1% (P/N: 1016-3392). R5 (500 ohm trimpot) now P/N: 1410-0015. R20 (5K trimpot) now P/N: 1410-0017. R7 (1M trimpot) now P/N: 1410-0020.
3. Pages 5-2/5-3, Parts List, THD Analyzer: U108 same as U106 (P/N: 0100-0001). U105 now type 2605 grade 6 (P/N: 0100-0014). R213 now 18.2K, 1% (P/N: 1015-2182). R203 now 120 ohms, 5% (P/N: 1100-0120). R359 now 750 ohms, 5% (P/N: 1100-0750). R167 and R173 same as R130 (P/N: 1100-3100). R170 same as R149 (P/N: 1100-4100). R157 etc. and R354 (100 ohm trimpot) now P/N: 1410-0013. R146 etc. (1K trimpot) now P/N: 1410-0016. R129 etc. (100K trimpot) now P/N: 1410-0019. R351 (20K trimpot) now P/N: 1410-0018. C151 same as C107 (P/N: 2000-0027). C211 now 68 pf, 5% (P/N: 2000-0068). Entry for P/N: 2040-0000 (.01 uf) should read: C140, 141, 219, 220, 329, 330, 335, 336.
4. Page 5-3, Parts List, Power Supply: R610 same as R604 (P/N: 1015-1422). R609 same as R602 (P/N: 1015-1464). R606 now 1.5K, 1% (P/N: 1015-1150). R607 now 9.09K, 1% (P/N: 1015-1909). R603 and R614 (500 ohm trimpot) now P/N: 1410-0015.
5. Page 5-3, Parts List, Anal Freq 3rd Digit: R67 now 392K, 1% (P/N: 1016-3392). R66 now 523K, 1% (P/N: 1016-3523). R65 now 806K, 1% (P/N: 1016-3806). R61 now 1.15M, 1% (P/N: 1016-4115). R60 now 1.33M, 1% (P/N: 1016-4133). R59 and R64 now 1.58M, 1% (P/N: 1016-4158). R58 now 2M, 1% (P/N: 1016-4200). R57 now 2.67M, 1% (P/N: 1016-4267). R56 now 4.02M, 1% (P/N: 1016-4402). R55 now 8.06M, 1% (P/N: 1016-4806).
6. Page 5-3, Parts List, Osc Freq 3rd Digit: R140, R149 now 392K, 1% (P/N: 1016-3392). R139, R148 now 523K, 1% (P/N: 1016-3523). R138, R147 now 806K, 1% (P/N: 1016-3806). R137, R146 now 1.58M, 1% (P/N: 1016-4158).
7. Page 5-3, Parts List, Input Switch: R140 same as R103 (P/N: 1005-1698). R119 now 909K, 1% (P/N: 1016-3909).
8. Page 5-3, Parts List, Ratio Switch: C325 now 35 uf (P/N: 2100-0023).

MODEL 1700B MANUAL CHANGE INFORMATION

1. The Sound Technology Model 1700B incorporates two design refinements not found on the 1700A: a front panel SIGNAL OFF switch, and an ANALYZER SELECT switch. The functions of these switches are as follows:

a. SIGNAL OFF: When depressed, this switch replaces the front panel SIGNAL OUTPUT jack with a floating short circuit. This enables the user to make signal-to-noise ratio measurements without the necessity of disconnecting cables.

b. ANALYZER SELECT: When depressed, this switch isolates the INPUT connectors, and allows the 1700B to monitor the signal appearing at the SIGNAL OUTPUT jack. The user may then select either VOLTS/POWER to measure the voltage output, or DISTORTION to measure the residual distortion of the output signal.

2. Late production versions of the 1700B incorporate two rear panel connectors to facilitate interconnections between the 1700B and the Sound Technology Model 1200A Stereo Test Panel. These connectors are: EXT FILTERS and SYNC OUT; their use is fully explained in the 1200A Instruction Manual.

3. With the exception of the added switches and connectors as described above, the balance of this manual is fully usable with either the 1700A or the 1700B.

IMPORTANT

THE PUSHBUTTON SWITCHES ARE PERMANENTLY LUBRICATED. APPLICATION OF ANY LUBRICANT OR CONTACT CLEANER WILL SHORTEN THEIR OPERATIONAL LIFE.

CONTENTS

Section		Page
I	OPERATION.1-1
	1-1. SCOPE OF SECTION1-1
	1-2. INTRODUCTION1-1
	1-3. INPUT POWER REQUIREMENTS1-1
	1-4. POWER CABLE.1-1
	1-5. CONTROLS AND INDICATORS.1-1
	1-6. TEST SETUP1-3
	1-7. Power Connections.1-3
	1-8. Ground Connections1-3
	1-9. Signal Connections1-3
1-10	OPERATING PROCEDURES1-5
	1-11. Test Connections1-6
	1-12. Meter Zero Mechanical Adjustment1-6
	1-13. Distortion Measurement1-6
	1-14. Distortion Measurement with External Oscillator.1-7
	1-15. AC Voltage/Power Measurement1-7
	1-16. AC Voltage Measurement-Extended Range.1-8
	1-17. Voltage Ratio Measurement.1-8
1-18.	AUDIO MEASUREMENTS1-9
	1-19. Maximum Power Output at Rated Total Harmonic Distortion at 1 kHz.1-9
	1-20. Power Bandwidth.1-9
	1-21. Hum and Noise/Signal-to-Noise Ratio.1-10
II	PRINCIPLES OF OPERATION.2-1
	2-1. INTRODUCTION2-1
	2-2. DISTORTION ANALYZER.2-1
	2-3. General Description.2-2
	2-4. Buffer Amplifier2-2
	2-5. Overload Detector.2-2
	2-6. Notch Filter2-2
	2-7. Distortion Amplifier and Attenuator.2-2
	2-8. Amplitude Null Control2-2
	2-9. Phase Null Control2-3
	2-10. Sum-Point Buffer2-3
	2-11. Tuning Indicator2-3
	2-12. Filters.2-4
	2-13. Function Switches.2-4
	2-14. AC Meter2-4
2-15.	OSCILLATOR2-4
	2-16. General Description.2-4
	2-17. Oscillator Circuit2-4
	2-18. Amplitude Control.2-4
2-19.	POWER SUPPLY2-6
	2-20. General Description.2-6
	2-21. Input Circuit.2-6
	2-22. + 15 Vdc Supply.2-6
	2-23. - 15 Vdc Supply.2-7

CONTENTS, Continued

Section		Page
III	MAINTENANCE.	3-1
	3-1. INTRODUCTION	3-1
	3-2. TEST EQUIPMENT	3-1
	3-3. PERFORMANCE CHECK.	3-1
	3-4. General Information.	3-1
	3-5. Overall System Check	3-1
	3-6. Distortion Test.	3-1
	3-7. Circuit Common Isolation Check	3-3
	3-8. Oscillator Check	3-3
	3-9. Frequency Test	3-4
	3-10. Distortion Test.	3-4
	3-11. Distortion Analyzer Check.	3-4
	3-12. dB Volts Test.	3-4
	3-13. Volts Power Test	3-5
	3-14. Filters Test	3-5
	3-15. Residual Noise Test.	3-6
	3-16. Common Mode Rejection Test	3-6
	3-17. ADJUSTMENT AND CALIBRATION PROCEDURE	3-6
	3-18. OSCILLATOR SECTION	3-7
	3-19. +15 Volt Adjustment.	3-7
	3-20. PhotoCell AC Voltage Adjustments	3-7
	3-21. Oscillator Integrator Voltage Change Adjustment.	3-7
	3-22. Oscillator Integrator Output and Adjustment.	3-7
	3-23. Oscillator X1000 Frequency Range Adjustment.	3-8
	3-24. ANALYZER SECTION	3-8
	3-25. Dc Zero Adjustment	3-8
	3-26. Null Adjustment.	3-8
	3-26A. Phase Null Integrator Voltage Adjustment	3-9
	3-27. Tuning Indicator Adjustment.	3-9a
	3-28. Calibration at 1 kHz	3-10
	3-29. TROUBLESHOOTING.	3-10
	3-30. SYMPTOM/CAUSE TABLE.	3-11
	3-31. COMPONENT REPLACEMENT - CALIBRATION and ADJUSTMENT	3-11
	3-32. REPLACEMENT and REPAIR	3-12
	3-33. Special Precautions.	3-12
	3-34. Contamination.	3-12
	3-35. WIRING	3-12
	3-36. SOLDERING TECHNIQUES	3-12
	3-37. COMPONENT REPLACEMENT.	3-12
	3-38. Multi-Lead Devices	3-15
	3-39. Potentiometers	3-15
	3-40. Power Supply	3-15
	3-41. FREQUENCY MODULE REPAIR.	3-15
	3-42. General.	3-15
	3-43. Removal/Replacement.	3-15
	3-44. Repair Instructions.	3-17
IV.	DIAGRAMS	4-1
	4-1. INTRODUCTION	4-1
	4-2. SCHEMATIC DIAGRAMS	4-1
	4-3. COMPONENT LOCATION DIAGRAMS.	4-1
V.	SPARE PARTS.	5-1
	5-1. INTRODUCTION	5-1
	5-2. ORDERING INFORMATION	5-1
	5-3. PARTS LIST	5-1

SECTION I OPERATION

1-1. SCOPE OF SECTION

The section contains information and instructions necessary for the operation of the Sound Technology Model 1700A Distortion Measurement System. Included are power requirements, cabling information and operating instructions.

1-2. INTRODUCTION

The Model 1700A Distortion Measurement System combines an ultra-low distortion oscillator, a high-resolution automatic-measuring distortion analyzer, and an accurate ac voltage/power meter in one instrument. Pushbutton operation permits the operator to quickly measure voltage or power, set level, and then measure distortion.

The oscillator section provides a pure sine wave signal for testing from 10 Hz to 110 kHz. Amplitude is variable from 3 volts to less than 1 mV.

The analyzer section contains a tracking notch filter which is always tuned to the oscillator frequency. The analyzer measures total harmonic distortion with a sensitivity ranging from 100% to .01% full scale, with automatic nulling on all ranges. Active filters may be selected for low frequency and high frequency noise suppression, enhancing the measurement resolution. A differential front end rejects common-mode noise.

The ac voltage/power meter inherent in the analyzer measures ac voltage, or power across an 8-ohm external load. The measurement range for ac voltage is 3 mV to 300 V full scale (30 μ V to 1 mV in Extended Range Para. 1-16) and for power is 1 μ W to 10 kW full scale. Voltage ratio measurements with a 100 dB or more of dynamic range can also be made.

1-3. INPUT POWER REQUIREMENTS

The Model 1700A System may be operated from either a 95-125 volt or 200-250 volt, 50 to 60 Hz power source. A two-position selector switch on the rear panel selects the power source. Before connecting the instrument to the power outlet, check that the selector switch setting matches the nominal line voltage of the source.

The Model 1700A System is protected from ac power overloads by a fuse (1A, fast-blown) located in a cartridge-type fuse holder on the rear panel.

1-4. POWER CABLE

The International Electrotechnical Commission (IEC) recommends that instrument panels and cabinets be grounded to protect operating and servicing personnel. The Model 1700A system is equipped with a three-conductor power cable assembly which, when plugged into the appropriate outlet, grounds the unit through the round offset pin.

1-5. CONTROLS AND INDICATORS

The data sheet at the front of the manual illustrates and describes briefly the Model 1700A Distortion Measurement System's front panel controls and indicators. The following provides additional explanatory information:

- a. POWER ON switch connects ac power to Model 1700A System. Pilot lamp glows when instrument is turned ON.
- b. +INPUT and -INPUT terminals -- Provide connections for signal being measured.
- c. GND (\uparrow) terminal -- Provides connection to chassis ground.
- d. COM (∇) terminal -- Provides connection to circuit common.
- e. VOLTS/POWER pushbutton -- Selects Volts or Power measurement function.

- f. INPUT switch -- Selects full scale meter range for Volts or Power measurement function. Readings are in volts rms or watts.
- g. OVERLOAD indicator -- Indicator is lit when input signal overloads input buffer. This warns operator that Volts or Power measurement is no longer accurate.
- h. SET LEVEL pushbutton -- Selects Set Level function whereby meter displays reference signal level for Distortion or Ratio measurement.
- i. SET LEVEL ADJUST -- Adjusts reference signal level for Distortion or Ratio measurement. When control is set to CAL position (max. counterclockwise), RATIO ranges extend voltage measurement capability to 30 μ V full scale (Paragraph 1-16).
- j. DISTORTION pushbutton -- Selects Distortion measurement function.
- k. dB VOLTS pushbutton -- Selects Ratio measurement function.
- l. RATIO Switch -- Selects full scale meter range for Distortion and Ratio measurement functions. Readings are in percent or dB.
- m. NOTCH FREQUENCY indicators -- Facilitate tuning when using an external oscillator. When LOW indicator is lit, Model 1700A System frequency is low with respect to incoming signal, when HIGH indicator is lit, Model 1700A System frequency is high with respect to incoming signal. System is correctly tuned when both indicators are extinguished. (It is normal for one of these indicators to glow when there is no input to the 1700A.)
- n. SIGNAL COMMON switch -- Switches circuit common from chassis ground, breaking ground loops. FLOAT position floats (disconnects) circuit common of System from chassis ground; Chassis Ground (H) position connects circuit common of System to chassis ground.
- o. FILTERS -- 400 Hz pushbutton selects a filter which suppresses low-frequency noise (such as 60 Hz hum) below 400 Hz. 80 kHz pushbutton selects a filter which suppresses high-frequency noise above 80 kHz. The 80 kHz filter also reduces effects of AM radio station pickup. Both filters affect meter reading only on Distortion and Ratio measurement functions. They do not affect meter reading on Volts/Power, and Set Level measurement functions. The 400 Hz filter is usable with fundamental frequencies down to 400 Hz when making distortion measurements.
- p. METER -- Indicates signal level of measurement selected by Function pushbutton.
- q. DISTORTION OUTPUT BNC connector -- Provides distortion product of signal being analyzed (suitable for viewing on oscilloscope) on Volts/Power, Set Level, and Distortion measurement functions. On Ratio measurement function, this output provides a scaled version of input signal. Output is 31.6 mV full scale.
- r. FAST RESPONSE/LOW DISTORTION switch -- Selects operating mode of oscillator. FAST RESPONSE causes oscillator amplitude to settle quickly after a frequency change. This mode is recommended when ultra-low distortion measurements are not required, for example when making frequency response measurements. LOW DISTORTION selects full ultra-low distortion capability of oscillator. The settling time in this mode is less than 5 seconds. Actuation of FREQUENCY pushbuttons generally causes oscillator to go first to FAST RESPONSE mode and then to settle in LOW DISTORTION mode. This switch controls only the oscillator and is not connected to the distortion analyzer.
- s. FAST RESPONSE indicator -- Indicates operating mode of oscillator. When lit, oscillator is in Fast Response mode and does not have ultra-low distortion.
- t. FREQUENCY pushbuttons -- Simultaneously select oscillator and distortion analyzer frequency. Four Multiplier switches and 30 Digit switches permit 3-digit resolution within each range. Frequency range of Model 1700A System is 10 Hz to 109.9 kHz. One button in each row must be depressed at all times.

- u. OSCILLATOR LEVEL control -- Adjusts amplitude of oscillator. Level is variable from 3 volts to below 1 millivolt. Control is single-turn logarithmic potentiometer.
- v. SIGNAL OUTPUT BNC connector -- Provides oscillator output signal. Output impedance varies with setting of OSCILLATOR LEVEL control and reaches a maximum of 625 ohms at mid-range.
- w. BUFFERED INPUT SIGNAL BNC connector (located on rear panel) -- Provides replica of input signal being analyzed. This signal is referenced to ground and intended to be connected to an oscilloscope.

1-6. TEST SETUP

In order to take full advantage of the unique ultra-low distortion measuring capabilities of the Model 1700A System it is extremely important that the cabling between the Model 1700A, the amplifier under test, and other test equipment be connected in compliance with the arrangement shown in Figure 1-1 and described in the following paragraphs. The connections and controls numbered in Figure 1-1 are similarly identified in the test. These connections have been found to provide the optimum test setup in most cases.

1-7. POWER CONNECTIONS

- a. Check that power slide switch on rear panel of Model 1700A is set to correct position for available ac power (see Paragraph 1-3 for details).
- b. Do not float the earth ground lead of the power cord of the Model 1700A. (The differential input makes this step unnecessary for breaking ground loops.)
- c. Plug the Model 1700A, amplifier under test and the oscilloscope (if used) closely to each other into the ac power bus.

1-8. GROUND CONNECTIONS

- a. Connect Model 1700A GND (⏏) terminal (1) to ground terminal (chassis ground) of amplifier under test.

NOTE

This reduces common mode 60-Hz potential differences and provides a path to ground for 60-Hz current that may be injected into the chassis of the amplifier under test from its own primary power circuits.

- b. Connect oscilloscope (if used) to BUFFERED INPUT SIGNAL BNC connector (2) on rear panel of Model 1700A via cable (3).

NOTE

1. This output is from the differential to single-ended converter in the Model 1700A which provides a replica of the input signal. This signal is referenced to ground.

2. If a BNC cable is not used for this connection, the oscilloscope common (low) terminal must be returned to the Model 1700A System GND (⏏) terminal (1) via a direct connection (4).

- c. This completes the ground connections necessary for proper Model 1700A operation.

1-9. SIGNAL CONNECTIONS

CAUTION

CONNECTING OSCILLATOR OUTPUT TO A HOT CHASSIS MAY BLOW FUSE, F2 or F3.
(Fuses located on bottom of instrument. A blown fuse will make FLOAT switch ineffective and cause hum problems.)

DO NOT EXCEED THE INPUT VOLTAGES LISTED BELOW TO PREVENT BLOWING F101 AND F102.

With Input Range Switch -- 3 V and Lower.

1. 300V Below 60 Hz
2. 50 V Above 1 kHz

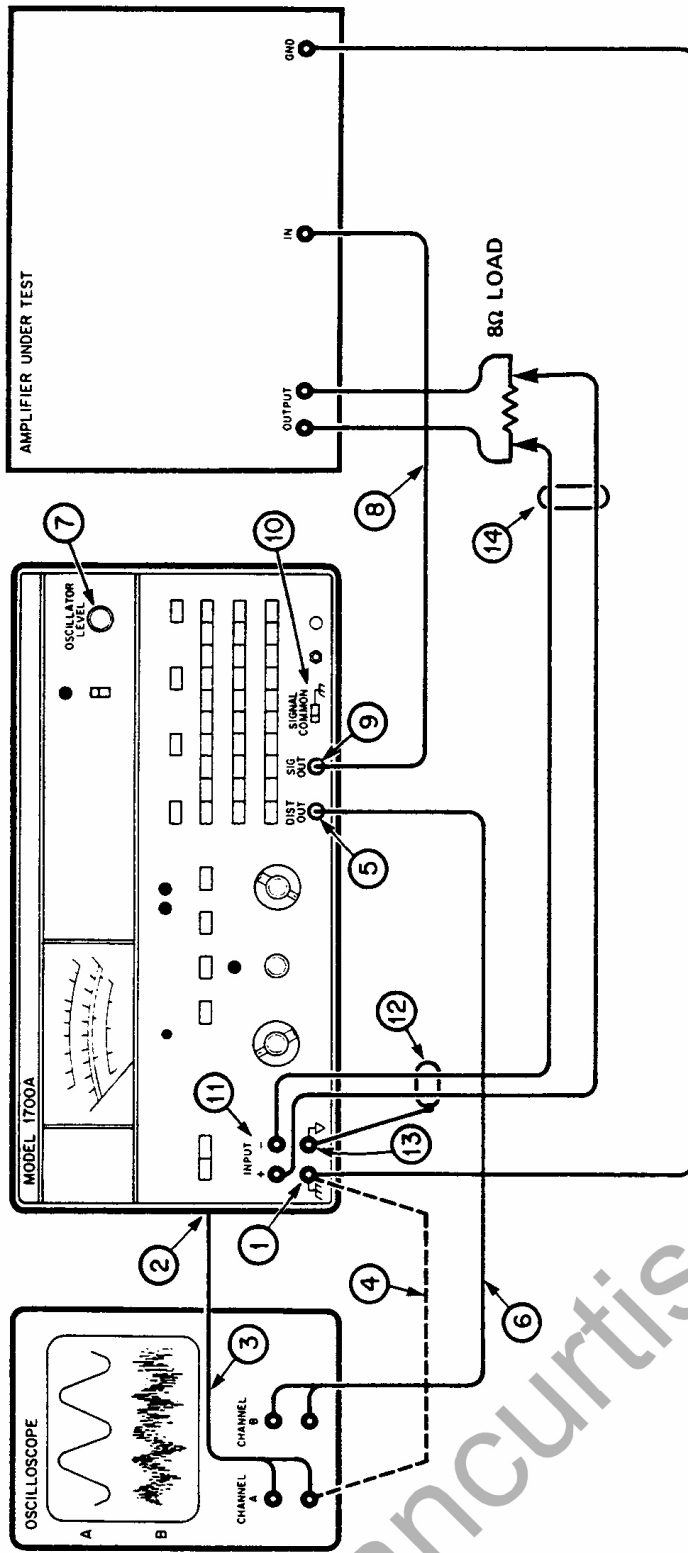

Figure 1-1 Model 1700A Test Setup

- a. Connect oscilloscope (if used) to DISTORTION OUTPUT connector (5) via cable (6). This permits monitoring the distortion products of the signal being analyzed.

NOTE

The shell of the DISTORTION OUTPUT BNC connector is returned inside the Model 1700A System to circuit common through a 1 μ F capacitor. The shell of the rear-panel BNC connector is at chassis ground. The above connections place this 1 μ F between the Model 1700A System circuit common and the chassis when using an oscilloscope. This permits reasonably noise-free viewing of the waveforms while still retaining a considerable amount of immunity to ground loop currents flowing between the Model 1700A SIGNAL OUTPUT and the input of the amplifier under test.

- b. Turn OSCILLATOR LEVEL control (7) fully counterclockwise (minimum level).
c. Set gain control on amplifier under test to its lowest setting.
d. Connect cable (8) between SIGNAL OUTPUT BNC connector (9) and input of amplifier under test.
e. Set SIGNAL COMMON switch (10) to FLOAT.

NOTE

This achieves the ultimate rejection of unwanted power-line related noise (especially in the leads of the input of the amplifier under test). With no other equipment such as an oscilloscope connected to the system, there is only a nominal .001 μ F of capacitance between the System circuit common and chassis ground. The corresponding reactance, greater than 2 megohms at 60 Hz, effectively opens the ground loops between the Model 1700A and the amplifier under test.

- f. Connect output of amplifier under test to a suitable 8 ohm load resistor. (Load resistor should be in a location free from any ac magnetic field, such as caused by a power transformer, to avoid hum pickup).
g. Connect signal to be measured (voltage developed across 8 ohm load) between +INPUT and -INPUT terminals (11). Use shielded twisted-pair cable for this connection and keep test leads as short as possible to avoid extraneous pick up from stray ac fields.
h. Connect shield (12) of input wiring to COM (∇) terminal (13). Leave shield (14) at other end unconnected.

NOTE

1. The input terminals do not have a polarity (as indicated) for ac and may be connected either way with no damage to the amplifier under test.

2. Each INPUT terminal has its own input attenuator and buffer amplifier. Input impedance is 100 kilohm from each terminal to the Model 1700A System circuit common. The true differential input circuits of the Model 1700A System help break the ground loop that causes 60-Hz pickup on the input leads of most measuring equipment.

3. Do not connect one channel of the oscilloscope directly to the output of the amplifier under test as this can upset the noise rejection capability of the Model 1700A System differential input circuitry. If it is absolutely essential to monitor this signal, leave the ground lead of the scope channel disconnected from the amplifier under test.

1-10. OPERATING PROCEDURES

CAUTION

CONNECTING OSCILLATOR OUTPUT TO A HOT CHASSIS MAY BLOW FUSE, F2 or F3.
(Fuses located on bottom of instrument. A blown fuse will make FLOAT switch ineffective and cause hum problems.)

DO NOT EXCEED THE INPUT VOLTAGES BELOW TO PREVENT BLOWING FUSES F101 AND F102

With Input Range Switch -- 3V and Lower

1. 300 V Below 60 Hz
2. 50 V Above 1 kHz

1-11. TEST CONNECTIONS

Before making measurements with the Model 1700A System, ensure that the equipment has been connected as shown in Figure 1-1 and following the instructions given in Paragraphs 1-6 through 1-9.

1-12. METER MECHANICAL ZERO ADJUSTMENT

The meter is correctly zero set when the pointer rests over the zero calibration marks on the scale when the Model 1700A INPUT switch is set to 300 V, the VOLTS POWER pushbutton is depressed, and there is no input signal (input leads disconnected). To adjust the zero set proceed as follows:

- a. Rotate zero adjustment screw (located on front panel below meter) until pointer is left of zero. Reverse rotation until pointer is exactly at zero.

1-13. DISTORTION MEASUREMENT

To measure the total harmonic distortion of a signal, proceed as follows:

- a. Set FAST RESPONSE/LOW DISTORTION switch to LOW DISTORTION and select fundamental test frequency in Hz by depressing appropriate FREQUENCY pushbuttons.

NOTE

1. Four Multiplier pushbuttons (X1, X10, X100, X1000) and 30 Digit pushbuttons permit 3-digit resolution of frequency selection. For example, 453 Hz would be selected by depressing the following pushbuttons:

<u>Multiplier</u>	<u>1st. Digit</u>	<u>2nd. Digit</u>	<u>3rd. Digit</u>	<u>Frequency</u>
X10	40			$40 \times 10 = 400$
		5		$5 \times 10 = 50$
			.3	$.3 \times 10 = 3$
				<hr/> 453 Hz

The "100" Digit pushbutton provides a 10% overlap in range. For example, 1010 Hz can be selected in two ways:

<u>Multiplier</u>	<u>1st. Digit</u>	<u>2nd. Digit</u>	<u>3rd. Digit</u>	<u>Frequency</u>
X10	100			$100 \times 10 = 1000$
		1		$1 \times 10 = 10$
			0	$0 \times 10 = 0$
				<hr/> 1010 Hz
X100	10			$10 \times 100 = 1000$
		0		$0 \times 100 = 0$
			.1	$.1 \times 100 = 10$
				<hr/> 1010 Hz

2. In the X1 range, operation of the frequency pushbuttons may not always cause the oscillator to go through its automatic stabilization cycle. If the oscillator amplitude appears to be unstable, momentarily set the FAST RESPONSE/LOW DISTORTION switch to the FAST RESPONSE position and then return it immediately to the LOW DISTORTION setting.

- b. Depress VOLTS POWER pushbutton and set ADJUST control fully CCW to CAL position.
- c. Set INPUT switch to expected range setting.
- d. Adjust OSCILLATOR LEVEL control and/or gain control on amplifier under test for desired voltage/power level as indicated on Model 1700A meter. Up range INPUT switch when meter pointer passes full scale and down range when meter pointer goes below 1/3 of full scale.

NOTE

If OVERLOAD indicator lights and meter reads less than full scale, meter reading is incorrect due to ADJUST control being incorrectly set. To regain accuracy, turn ADJUST control down (CCW) until OVERLOAD light is OFF.

- e. Depress SET LEVEL pushbutton and rotate set level ADJUST control until meter pointer rests on SET LEVEL mark.
- f. Depress DISTORTION pushbutton and rotate RATIO switch until meter pointer reaches upper 2/3's of scale. If desired, depress 400 Hz and/or 80 kHz FILTER pushbutton to filter noise from input signal.
- g. Observe distortion either in percentage or dB, as indicated by meter deflection and RATIO switch setting. For example, if meter reads .67 and RATIO setting is .1%, distortion measured is .067%.

1-14. DISTORTION MEASUREMENT WITH EXTERNAL OSCILLATOR

- a. Connect equipment as shown in Figure 1-1, with the following exceptions:
 - 1. Connect power cord of external oscillator to power source close to source used by Model 1700A, amplifier under test, and oscilloscope.
 - 2. Connect output of oscillator to input of amplifier under test. The oscillator output may be floated if this gives better test results.
 - 3. Connect chassis of oscillator to GND (⏏) terminal on Model 1700A.
 - 4. Set SIGNAL COMMON switch on Model 1700A to ⏏ (ground) position.
- b. Set external oscillator to desired frequency and signal level.
- c. Preset Model 1700A FREQUENCY pushbuttons to approximate frequency of external oscillator.
- d. Set ADJUST control fully counterclockwise (CCW) to CAL position and depress VOLTS POWER pushbutton.
- e. Set INPUT switch to expected range.
- f. Adjust external oscillator amplitude control and/or gain control of amplifier under test for desired voltage/power level as indicated on Model 1700A meter.
- g. Depress SET LEVEL pushbutton. Rotate ADJUST control until Meter pointer rests on SET LEVEL mark.
- h. Set 1700A frequency or external oscillator frequency so both NOTCH FREQUENCY indicators are off and that the tuning is approximately centered.
- i. Depress DISTORTION pushbutton and set RATIO switch so that meter pointer rests within upper 2/3's of scale. If desired, depress 400 Hz and/or 80 kHz pushbutton to filter noise from input signal.
- j. Observe distortion in either percentage or dB, as indicated by meter deflection and RATIO range setting.

1-15. AC VOLTAGE/POWER MEASUREMENT

The Model 1700A is an accurate ac voltage/power meter over its entire frequency range. The power scale is calibrated for an 8-ohm load, which must be provided externally. Voltage may be measured directly from 3 mV to 300 V full scale and power from 1 μ V to 10 kW full scale. To measure ac voltage or power, proceed as follows:

- a. Ensure that the power and ground connections are as described in Paragraphs 1-7 and 1-8 respectively.

- b. Connect signal to be measured between + INPUT and - INPUT terminals. Use shielded twisted-pair cable for low-level inputs. Connect shield to COM (∇) terminal.
- c. Set ADJUST control to CAL position and depress VOLTS POWER pushbutton.
- d. Rotate INPUT switch for an on scale reading (pointer in upper 2/3's of scale).

NOTE

The 400 Hz and 80 kHz FILTERS do not affect readings on the ac Voltage Power measurement function.

1-16. AC VOLTAGE MEASUREMENT - EXTENDED RANGE

The sensitivity of the ac voltmeter can be extended to 30 μ V full scale through the use of the RATIO switch. To obtain this increased sensitivity carry out the following steps:

- a. Ensure that power and ground connections are as described in Paragraphs 1-7 and 1-8 respectively.
- b. Connect signal to be measured between + INPUT and - INPUT terminals. Use shielded twisted-pair cable for signal connection. Connect shield to COM (∇) terminal.
- c. Set Model 1700A controls as follows:
 dB VOLTS switch ----- depressed
 INPUT switch ----- .3 V
 ADJUST control ----- CAL
- d. Meter full scale sensitivity is now controlled by RATIO switch as follows:

<u>RATIO switch</u>	<u>Full Scale Sensitivity</u>
-80 dB	30 μ V
-70 dB	100 μ V
-60 dB	300 μ V
-50 dB	1 mV

NOTE

The 400 Hz and 80 kHz FILTERS will affect meter readings in this mode of operation.

1-17. dB VOLTS MEASUREMENTS

The dB Volts function facilitates the measurement of voltage ratio, signal-to-noise ratio, and frequency response, in dB or percent. The signal-to-noise ratio measurement described below provides an example of the use of this function.

- a. Ensure that power and ground connections are as described in Paragraphs 1-7 and 1-8 respectively.
- b. Set ADJUST control to CAL position and depress VOLTS POWER pushbutton.
- c. Set INPUT switch to expected range and adjust appropriate signal level controls for desired output signal, as indicated on meter.
- d. Depress SET LEVEL pushbutton and rotate ADJUST control until meter pointer rests on 0 dB mark.

NOTE

For proper 0 dB or 100% set level, reference signal must be at least .1 V and not exceed 300 V.

- e. Remove input signal to amplifier under test and replace with a short circuit across amplifier's input terminals. Set SIGNAL COMMON switch to \uparrow (ground) position.

NOTE

When the input signal to the amplifier under test is removed and replaced with a short, this floats entire Model 1700A measuring circuits. Proper grounding can be restored by setting the CIRCUIT COMMON switch to the \downarrow (ground) position.

- f. Depress dB VOLTS pushbutton. Select RATIO switch range which places meter pointer in upper 2/3's of scale, Read test result in dB.
- g. At end of signal-to-noise ratio measurement, return SIGNAL COMMON switch to FLOAT position.

1-18. AUDIO MEASUREMENTS

Operating instructions for performing certain audio measurements as specified by the Institute of High Fidelity (1960) are given below. For these tests, ensure that the following test conditions are maintained:

- a. Line: 120 V \pm 1%, 60 Hz, less than 2% total harmonic distortion.
- b. Temperature: 25 \pm 3⁰ C.
- c. Preconditioning: Unit under test should be preconditioned for 1 hour at 1/10 rated power. (FTC requires 1/3 rated power).
- d. Amplifier Gain Controls: Set to maximum.
- e. Amplifier Tone Controls: Flat.
- f. Amplifier Balance Control: Set to normal.
- g. Test Equipment: Model 1700A exceeds all IHF requirements for test equipment accuracy.

1-19. MAXIMUM POWER OUTPUT AT RATED TOTAL HARMONIC DISTORTION AT 1 kHz

NOTE

Amplifier must be able to maintain this power for 30 seconds.

- a. Set Model 1700A for frequency output 1 kHz.
- b. Connect SIGNAL OUTPUT to amplifier's AUX or TAPE INPUT on all channels.
- c. Set RATIO SWITCH so that amplifier's rated distortion gives maximum on-scale reading, and observe distortion products on oscilloscope.
- d. Increase OSCILLATOR LEVEL setting until distortion products on oscilloscope are excessive while (1) monitoring power with VOLTS POWER pushbutton depressed and (2) keeping signal on scale with INPUT switch.
- e. When excessive distortion products are present, refine measurement by adjusting OSCILLATOR OUTPUT while measuring distortion until the amplifier's rated distortion is reached.
- f. Switch Model 1700A to VOLTS POWER function and determine amplifier's power output at rated distortion.

1-20. POWER BANDWIDTH

- a. Maintain test setup as described in Paragraph 1-19.
- b. Adjust amplifier level until power is 3 dB below rated power (1/2 power) at midband (full rated power for FTC).
- c. Increase Model 1700A frequency in steps from midband while measuring distortion. Stop when distortion is equal to amplifier's specifications. This is upper power bandwidth point.

- d. Repeat step c, this time decreasing Model 1700A frequency until lower power bandwidth point is found. The result may be expressed briefly (for example: Power Bandwidth = 15 Hz to 37 kHz); or it may be shown as a graph of distortion versus frequency, with power held constant at 3 dB below rated power.

1-21. HUM and NOISE or SIGNAL-to-NOISE RATIO

Make this measurement following the instructions given in Paragraph 1-17 for measuring voltage ratios. Drive the amplifier to its rated power output with gain controls set to maximum. Then remove the input and obtain a dB ratio reading as described in 1-17.

www.stancurtis.com

SECTION II PRINCIPLES OF OPERATION

2-1. INTRODUCTION

The Model 1700A Distortion Measurement System consists of an ultra-low distortion oscillator, a total harmonic distortion analyzer, and a dc power supply. The system makes total harmonic distortion measurements by applying a sine-wave of ultra-low distortion from the oscillator to the input of the amplifier under test while the distortion analyzer measures the amplifier output. A tunable notch filter in the analyzer, mechanically ganged to the oscillator by the front panel frequency select switches, suppresses the fundamental signal. Automatic nulling circuitry fine tunes the notch filter and ensures that the null is retained. The signal remaining at the output of the notch filter consists of the distortion products and noise. This is displayed by an average-reading voltmeter in the analyzer. The ratio of the measured distortion components to a previously set fundamental signal reference level is defined as the total harmonic distortion and can be read out directly on the meter in percent or dB. Switchable low-frequency and high-frequency filters are provided to enhance the readout of the harmonic products.

Other features of the Model 1700A include separate Voltage and Distortion measurement range switches, separate Set Level monitoring without range changing, and automatic nulling on all ranges.

The power supply provides regulated dc voltages of +15 volts and -15 volts to power the oscillator and analyzer. Both of these supplies are internally protected against accidental short circuit.

2-2. DISTORTION ANALYZER

2-3. GENERAL DESCRIPTION

Refer to Figure 4-2 for a schematic diagram of the distortion analyzer assembly. Note that the circuit is divided into the following circuit blocks: Buffer amplifier, overload detector, notch filter, distortion amplifier and attenuator, amplitude null filters, function switches, and ac meter. The operation of the assembly is discussed first at a circuit block level and is then followed by details of each block.

In operation, the signal to be measured is connected to the input of the buffer amplifier. This circuit has two outputs: a fixed output which may be connected to the ac voltmeter, and a variable output (controlled by the ADJUST control) which is connected to the notch filter. The voltmeter is an average reading type which measures the signal level selected by the appropriate function switch.

The overload detector monitors the variable output of the buffer amplifier. If an excessively high output voltage is detected, the detector turns on the front panel OVERLOAD indicator.

The notch filter is mechanically ganged to the oscillator frequency select switches and suppresses the fundamental from the output of the buffer amplifier. The output of the notch filter is connected to the input of the distortion amplifier through a step attenuator controlled by the front panel RATIO switch. The attenuator adjusts signal level for the distortion amplifier for various percentages of distortion or ratio readings.

The amplitude null control and phase null control circuits supply the notch filter with its automatic nulling feature. Both circuits monitor the output of the distortion amplifier and feed control signals back to the notch filter.

The sum-point buffer supplies reference signals to the tuning indicator and to the amplitude null control circuit.

The tuning indicator circuit, using frequency information from the notch filter, provides the operator with a visual indication of the frequency being analyzed versus the input frequency. This circuit operates the NOTCH FILTER HIGH and LOW indicators.

The switchable low-frequency and high-frequency filters are connected to the output of the distortion amplifier. This permits them to be selected for DISTORTION and dB VOLTS measurements only.

The switchable low-frequency and high-frequency filters are connected to the output of the distortion amplifier. This permits them to be selected for DISTORTION and dB VOLTS measurements only.

The function switches select the circuit to be measured by the ac voltmeter. When the VOLTS POWER switch is depressed, the meter monitors the output via a stepped attenuator from the buffer amplifier. When the SET LEVEL switch is depressed, the meter monitors the variable output of the buffer amplifier. Operation of the DISTORTION switch routes the signal from the distortion amplifier via the low-frequency and high-frequency filters (if selected) to the meter. When the dB VOLTS switch is depressed, it connects the variable output from the buffer amplifier directly to the attenuator at the input of the distortion amplifier and hence to the meter.

2-4. BUFFER AMPLIFIER

The input of the buffer amplifier contains a pair of step attenuators, one for each INPUT connector. The attenuators are controlled by Sections S1A, B, C, D of the INPUT switch. The attenuator outputs are connected to input signal preamplifiers U101 and U102. The gain of these units is controlled by section S1E of the INPUT switch. Gain is unity on the 3 V range and above, 3.16 on the 1 V range, and 10 on the .3 V range and below. The preamplifier outputs are coupled to U103, a bridge amplifier circuit which effectively acts as a differential to single-ended converter with high common-mode noise rejection. The gain of the bridge amplifier is controlled by ADJUST potentiometer R125 and provides the variable signal supplied by the buffer. The range of gain is 10 dB and full scale voltage is 3.16 volts. The fixed output from the buffer is obtained between the wiper of R125 and ground. This signal remains fixed regardless of the setting of R125, except when the buffer overloads.

2-5. OVERLOAD DETECTOR

The overload detector signals an overload condition when the variable output of the buffer amplifier exceeds approximately 6.5 volts rms sine wave or 9 volts peak. The circuit consists of comparator U107, a half-wave rectifier and filter, a light-emitting diode driver, and OVERLOAD indicator CR120.

2-6. NOTCH FILTER

The notch filter consists of two 90-degree phase shifters connected in series, making the output 180 degrees out of phase with the input. By summing the input and output at summing amplifier U203, the fundamental of the input signal is cancelled out. Feedback from the output of the summing amplifier to the input of the filter increases the Q of the circuit and narrows the rejection band of the filter.

Tuning is controlled by changing a set of RC elements for each phase shifter through operation of the front panel Multiplier and Digit pushbutton switches. When the reactance of the capacitance equals the resistance at the incoming frequency, the phase shift is 90 degrees. The RC components are contained in the frequency module (see Figure 4-5 for schematic diagram).

2-7. DISTORTION AMPLIFIER AND ATTENUATOR

The output of the notch filter is coupled through a 7-step attenuator to the input of distortion amplifier U204. The attenuator is controlled by section S2D of the front panel RATIO switch and reduces the distortion product of the notch filter such that the full scale voltage input to the amplifier is 1 mV on ranges .03% through 100% and .316 mV on the .01% range.

Amplifier U204 is a wide-band high-gain unit with gain controlled by section S2E of the RATIO switch. The gain is 31.6 for ranges .03% through 100% and 100 for the .01% range. This gives a full scale output voltage of 31.6 mV on all ranges.

2-8. AMPLITUDE NULL CONTROL

The amplitude null control circuit controls the amplitude of the signal from the cascaded phase shifter so that exact balance occurs when it is summed with the input to the phase shifters. This ensures the total cancellation of the fundamental signal. The components which perform this function include phase detector U310, floating integrator and voltage follower U312, integrating amplifier U311, integrating capacitors, and a photocoupler controlling a variable resistor element in the summing network.

The reference input to phase detector U310 is a signal which is in phase with the fundamental and the signal input to U310 is the distortion product output of the distortion amplifier. With these inputs, the phase detector monitors the notch filter output for an in-phase signal. When this occurs the output of the phase detector supplies drive to the integrator causing the charge on the integrating capacitors to change. This in turn causes the photocoupler to change the value of the variable resistor which in effect adjusts the summing current until the in-phase component is no longer there.

The integrating capacitors are changed by the RATIO attenuator switch. This in effect maintains the automatic null control loop gain at a relatively constant level, resulting in high-speed nulling on all ranges. The capacitors are precharged to the integrator output voltage level through resistor R360. This avoids switching transients and improves the speed of the circuit.

2-9. PHASE NULL CONTROL

The phase null control circuit fine tunes the phase of the second phase shifter in the notch filter so that the overall phase shift is exactly 180 degrees. This ensures total cancellation of the fundamental signal. The components which perform this function include phase detector U307, floating integrator and voltage follower U309, integrating capacitors, and a photocoupler controlling a variable resistor in the resistive branch of the second phase shifter.

The reference input to phase detector U307 is the distortion product output of the distortion amplifier. With these inputs the phase detector monitors the notch filter output for an out-of-phase signal. When this occurs, the phase detector output supplies drive to the integrator causing the charge on the integrating capacitors to change. The integrator output drives the variable gain amplifier, U313, and the voltage to current converter, U314, which in turn causes the photocoupler to change the value of the variable resistor which in effect adjusts the phase angle until the out-of-phase component is no longer there.

The integrating capacitors are changed by the RATIO attenuator switch. This in effect maintains the automatic null control loop gain at a relatively constant level, resulting in high-speed nulling on all ranges. The capacitors are precharged to the integrator output voltage level through resistor R344. This avoids switching transients and improves the speed of the circuit.

A set of resistors that feed signal from integrator U308 to U313, which acts as a gain control, is switched by the front panel FREQUENCY switches. This maintains a relatively constant integrator voltage when frequency is changed and helps to achieve perfect nulling in less than 5 seconds.

2-10. SUM-POINT BUFFER

The sum-point buffer supplies a signal from the notch filter summing point to the tuning indicator and the amplitude null control, each of which uses the signal as the reference input to a phase detector. The buffer consists of unity-gain amplifier U301 and high-gain high-speed amplifier U302. These components convert the sine wave at the summing point into a square wave signal.

2-11. TUNING INDICATOR

The tuning indicator monitors the phase relationship between the signal input to the notch filter's first phase shifter and its output. The relationship is frequency dependent and is 90 degrees when the incoming frequency is exactly the same as the tuned frequency of the notch filter. The components performing this function include phase detector U303, high-speed amplifier/drivers U304, U305 and HIGH and LOW indicators CR301, CR302.

The reference input to phase detector U303 is the signal at the input to the phase shifter (connected via the sum-point buffer) and the signal input to U303 is the output of the phase shifter. When the incoming frequency is exactly the same as the tuned frequency of the notch filter (90-degree phase relationship), there is no output from the phase detector. Under these conditions both indicators are off. However, if the frequency of the notch filter is high compared with the input frequency, U303 produces a dc output which turns on the HIGH indicator. Conversely, if the frequency of the notch filter is low compared with the input frequency, a dc output of the opposite polarity from U303 turns on the LOW indicator.

2-12. FILTERS

Each filter is an active 3-pole Butterworth having a flat response within its pass-band and an attenuation slope of -18 dB/octave. The -3 dB point is 80 kHz for the low-pass filter and 400 Hz for the high-pass filter.

2-13. FUNCTION SWITCHES

The function switches select the circuit to be measured by the ac voltmeter. When the VOLTS POWER switch is depressed the meter monitors the fixed output, via a step attenuator, from the buffer amplifier. When the SET LEVEL switch is depressed, the meter monitors the signal from a divider connected to the variable output of the buffer amplifier. Operation of the DISTORTION switch routes the signal from the distortion amplifier via the low-frequency and high-frequency filters (if selected) to the meter. This connection is not made directly by the DISTORTION switch but by the release of the SET LEVEL and VOLTS POWER switches which occurs automatically when the DISTORTION switch is depressed. When the dB VOLTS switch is depressed, it connects the variable output from the buffer amplifier directly to the attenuator at the input of the distortion amplifier and hence to the meter.

2-14. AC METER

The ac meter circuit consists of high-gain wide-band amplifier U104, a full-wave bridge rectifier circuit, and dc milliammeter M1. It indicates the average value of an ac signal. The input sensitivity is 31.6 mV full scale. The gain of the meter is adjusted by potentiometer R157.

2-15. OSCILLATOR

2-16. GENERAL DESCRIPTION

Refer to Figure 4-4 for a schematic diagram of the oscillator assembly. The oscillator is basically a Wein bridge type with a unique ultra-low distortion amplitude control circuit. This control circuit provides (1) wide frequency range (2) fast settling (3) flat frequency response and (4) ultra-low distortion. No one of these characteristics is sacrificed in order to achieve an improvement in the others.

The oscillator has two operating modes - Fast Response and Low Distortion. When Fast Response is selected the oscillator amplitude settles quickly after a frequency change; when Low Distortion is chosen, the oscillator settling time to .002% distortion is less than 5 seconds. Built-in control circuitry automatically guides the oscillator through these modes whenever there's disturbance to the amplitude, for example, a change of frequency setting.

2-17. OSCILLATOR CIRCUIT

The basic Wein bridge oscillator consists of a reactive positive feedback network and a resistive negative feedback network, both of which are tied to the output of oscillator amplifier U1. The positive feedback network feeds back to the positive terminal of the amplifier and the negative feedback network is coupled to the negative terminal of the amplifier. Frequency of oscillation is determined in the positive feedback network by the relationship:

$$f = \frac{1}{2 \pi RC}$$

Where front panel Multiplier switches change a set of capacitors for each frequency range and the Digit switches change the resistance value. These components are located in the frequency module (see Figure 4-5 for schematic diagram).

2-18. AMPLITUDE CONTROL

The ultra-low distortion amplitude control circuit consists of two control loops: A high-speed loop and a low-speed loop. These two loops, acting together, effectively vary the negative feedback ratio to regulate the oscillator amplitude.

The high-speed loop, composed of the following major components, stabilizes the oscillator from cycle to cycle.

- a. Peak Detector Q2, Q3.
- b. Active RC filter U2 and associated RC element.
- c. Voltage-controlled resistor (VCR) Q1.

The low-speed loop, consisting of the following major components, monitors the bias applied to the VCR and ensures that the bias is always at an optimum value for low distortion.

- a. Comparator R17, R18 (these components are also input resistors for integrator U3).
- b. Integrator U3 and associated integrating capacitor.
- c. Photocoupler U7.

In the following circuit description, assume that the oscillator has been set for Fast Response operation. In this mode relays K1 and K2 are de-energized, resulting in the following circuit conditions:

- a. The time constant for active RC filter U2 is relatively short.
- b. The time constant for integrator U3 is relatively short.
- c. A high value of resistance is connected in parallel with the VCR section of the negative feedback loop. This allows the VCR to have a wide control range.

In operation, when power is first applied to the unit, there is no input from the oscillator. This causes the output of RC filter U2 to be zero and VCR Q1 to be at its lowest resistance. At the same time, the output of integrator U3 is also zero, which cuts off the drive to the light source in U7. This causes the photoresistor to have a very high resistance. These conditions result in a very low negative feedback ratio in the oscillator, causing it to start immediately after power is applied.

When the oscillator amplitude passes a reference voltage (voltage V2 across R15) at peak detector Q2, Q3, the detector produces an output current which starts to charge up RC filter U2. This in turn creates a large bias voltage (V1) to the VCR which increases its resistance. This tends to lower the amplitude of the oscillator. At the same time, comparator R17, R18 detects that voltage V1 is increasing and when it becomes greater than its reference voltage (V3), the comparator produces a current which drives integrator U3 to turn on the light source in U7. The photoresistor responds by decreasing its resistance, tending to further dampen the amplitude of the oscillator. This action continues until (1) The oscillator amplitude equals the reference voltage (V2) and (2) the VCR bias voltage (V1) equals the reference voltage (V3).

After the oscillator has reached a steady state condition, the circuit continues to operate as follows: Any time the oscillator amplitude is lower than the reference voltage (V2), the ac peak detector Q2, Q3 reduces drive to the RC filter and VCR. This in turn causes the VCR to decrease its resistance, bringing the oscillator amplitude back to the reference level (V2). If the oscillator amplitude is higher than the reference, a reverse action increases the VCR resistance. This operation occurs once per cycle and is performed by the high-speed loop.

The bias (V1) on the VCR is constantly monitored by comparator R17, R18 against reference voltage V3. Any difference in voltage level results in a current of corresponding polarity. This current is integrated constantly by integrator U3. Over a given period of time, if there is an average net increase of VCR bias, there will be an increase of drive to the light source of U7. (The opposite is true for a net decrease of VCR bias). This increase in drive to the light source will result in a decrease of resistance in photoresistor U7. When this occurs, the VCR is no longer required to have such a high resistance and hence high bias voltage V1. Therefore, the bias voltage (V1) for the VCR will gradually return to its predetermined value, the reference voltage V3. This action, which provides a constant optimum bias for the VCR, is performed by the low-speed loop.

Now assume that the oscillator has been set for Low Distortion operation and it is in a steady state condition. At this time, relays K1 and K2 are energized resulting in the following circuit conditions:

- a. The time constant for active RC filter U2 is now longer. This filters the sawtooth voltage driving VCR Q1 to almost a dc level, minimizing its distortion effect.
- b. The time constant for integrator U3 is now longer. This ensures that the stability of the control system is maintained.
- c. Resistor R8 is shunted in parallel with VCR Q1. This greatly limits the control range of the VCR, reducing its distortion effort.

The oscillator remains in this state until a disturbance to the oscillator amplitude occurs. At this time, the high-speed loop, in an attempt to maintain the oscillator amplitude, creates an abnormal bias level for VCR Q1. This level is sensed by level detector Q4, Q5 which in turn triggers one-shots U6A, U6B with the result that relays K1 and K2 are de-energized. This places the amplitude control system in the Fast Response mode previously discussed. The system remains in this state for $2\frac{1}{2}$ seconds.

At the end of the $2\frac{1}{2}$ second interval, relay K1 is energized. This causes the following circuit action:

- a. A shunt is placed across VCR Q1 to limit its control range.
- b. The time constant of integrator U3 is increased to maintain circuit stability.
- c. A large capacitor is allowed to charge to the steady state output value of active RC filter U2.
- d. A large capacitor is allowed to charge to the steady state output value of integrator U3.

During this intermediate state, which also lasts $2\frac{1}{2}$ seconds, the oscillator settles to a steady state condition. At the end of this interval, relay K2 is energized. This causes the following circuit action:

- a. The precharged capacitor is connected across RC filter U2.
- b. The precharged capacitor is connected across the integrator U3.

Thus, after 5 seconds, the control system is back in the ultra-low distortion mode with relays K1 and K2 energized.

2-19. POWER SUPPLY

2-20. GENERAL DESCRIPTION

Refer to Figure 4-7 for a schematic diagram of the power supply. The assembly consists of a regulated +15 Vdc supply and a regulated -15 Vdc supply, both of which feature current foldback and current limiting.

2-21. INPUT CIRCUIT

Main power is coupled to the primary of transformer T1 via POWER switch S3, 115/230 Vac select switch S5, and fuse F1. Transformer T1 steps the main voltage down to the appropriate level for the individual power supply circuits.

2-22. +15 Vdc SUPPLY

Full wave rectifier CR601-604 and filter capacitor C601, connected to a secondary winding on T1, produce an unregulated output of approximately +28 Vdc. The regulation circuit includes pass element Q601, and integrated circuit regulator U601. Potentiometer R603 allows the output to be set to exactly +15 Vdc.

2-23. -15 Vdc SUPPLY

The -15 Vdc supply is similar to the +15 Vdc supply described above except that the outputs are reversed, resulting in a negative potential with respect to power supply ground. Also, the output of this supply is not adjustable.

SECTION III
MAINTENANCE

3-1. INTRODUCTION

This section provides performance checks, adjustment and calibration procedures, troubleshooting techniques, and repair instructions for the Model 1700A.

3-2. TEST EQUIPMENT

Recommended test equipment for performance checking and troubleshooting is listed in Table 3-1. Test instruments other than those described can be used provided their specifications equal or exceed those listed.

3-3. PERFORMANCE CHECK

CAUTION

Due to the ultra-low distortion characteristics of the Model 1700A, only test equipment with the specifications described in Table 3-1 is capable of making the distortion measurements called for in this check. Use of test equipment with equal or higher residual distortion to measure, for example, the low distortion oscillator, will result in erroneous readings due to:

- a. Residual distortion of measuring equipment.
- b. Reinforcement or cancellation effect of distortion products.

3-4. GENERAL INFORMATION

This check can be used as an incoming inspection check and the Overall System Check portion (Paragraph 3-5) can be used as a quick method of verifying correct system operation. If the correct results are not obtained, refer to the information contained in Troubleshooting (Paragraph 3-29).

Before beginning the check, ensure that all external equipment (oscilloscope, amplifier under test, etc.) is completely disconnected from the Model 1700A. Also ensure that none of the fuses described in paragraph 3-29 are blown.

3-5. OVERALL SYSTEM CHECK

3-6. Distortion Test

NOTE

1. Before beginning the test, ensure that all external equipment is completely disconnected from the Model 1700A.

2. This test measures the overall distortion of the system, with distortion from both the oscillator and the distortion analyzer contributing to the result. To measure the distortion of the analyzer assembly, an extremely pure source with a distortion of .0002% is required.

- a. Connect cable between SIGNAL OUTPUT BNC connector and INPUT terminals. Use - (minus) terminal for BNC shell.
- b. Set Model 1700A controls as follows:

SIGNAL COMMON switch-----	
INPUT switch-----	3 V
ADJUST control-----	CAL
OSCILLATOR LEVEL control-----	fully CW (max. level)
FAST RESPONSE/LOW DISTORTION switch-----	LOW DISTORTION
FREQUENCY pushbutton-----	X10
	100 = 1000 Hz
FILTERS pushbuttons-----	80 kHz

Table 3-1 Required Test Equipment

TYPE	REQUIRED CHARACTERISTICS	USE	RECOMMENDED MODEL
AC Calibrator	Voltages: 316.2 mV, 1.000 mV, 3.162 V rms Accuracy: $\pm .1\%$ at 1 kHz	Adjustment and Calibration	Fluke Model 5200A (*See alternate method described below).
Digital Multi-Meter	DC Voltage Range: 200 mV to 200 V $\pm .1\%$ AC Voltage Range: 200 mV to 200 V $\pm .5\%$ Resistance Range: 200 ohms to 20 M ohms $\pm .2\%$	Adjustment and Calibration Troubleshooting	Fluke Model 8000A
Frequency Counter	Frequency Range: 10 Hz to 110 kHz Period Measurements: 10 Hz to 1 kHz Accuracy: $\pm .1\%$	Adjustment and Calibration Troubleshooting	Fluke Model 1900A
Oscilloscope	Bandwidth: DC to 10 MHz Vertical: Dual Channel	Adjustment and Calibration Troubleshooting	Hewlett-Packard Model 1220A or Philips Model PM3232
Oscillator and THD Analyzer	Frequency Range: 10 Hz to 110 kHz Residual Distortion: .002%, 10 Hz to 10 kHz	Troubleshooting	Sound Technology Model 1700A

*To produce fairly accurate AC voltages: For 3.00 Vrms -- Monitor oscillator output with Digital Multimeter.

For 1.000 Vrms -- Set 1700A under test to 100 V range and set oscillator output for a 31.6 mV rms output with Digital Multimeter.

For .3162 mVrms -- Same as above except set 1700A under test to 300 V range.

- c. Depress SET LEVEL pushbutton and rotate ADJUST control until meter pointer is over SET LEVEL mark.
- d. Depress DISTORTION pushbutton and set RATIO switch to .01 range. Check that distortion reading is less than .004%.
- e. Select following oscillator frequencies and check that the distortion reading for each is less than the percentage given.

<u>Multiplier</u>	<u>Digit</u>	<u>Frequency</u>	<u>Distortion</u>
X10	10	100 Hz	.004
X1	10	10 Hz	.0045
X1	100	100 Hz	.004
X100	100	10 kHz	.004
X100	10	1 kHz	.004
X1000	10	10 kHz	.004

- f. Set RATIO switch to .3 range and change oscillator frequency to 100 kHz (X1000 and 100 pushbuttons).
- g. Release 80 kHz FILTER pushbutton. Check that distortion reading is less than .2%.

3-7. Circuit Common Isolation Check

- a. Disconnect all cables from Model 1700A and set POWER switch to OFF.
- b. Measure resistance between GND (\uparrow) and COM (\downarrow) terminals for each setting of SIGNAL COMMON switch. Check that readings are within tolerance given below:

<u>SIGNAL COMMON switch</u>	<u>Resistance</u>
FLOAT \uparrow	>10 megohm <1.2 ohm

- c. Set SIGNAL COMMON switch to \uparrow position and reconnect cable between SIGNAL OUTPUT and INPUT terminals. Set POWER switch to ON.

3-8. OSCILLATOR CHECK

3-9. Frequency Test

- a. Set Model 1700A controls as follows:

OSCILLATOR LEVEL control----- fully CW
 FAST RESPONSE/LOW DISTORTION switch----- FAST RESPONSE
 FREQUENCY pushbuttons----- X10 = 1 kHz
 100

- b. Connect SIGNAL OUTPUT BNC connector to frequency counter and wide-band ac voltmeter. Measure amplitude of oscillator output. Check that it exceeds 3 volts.
- c. Select following oscillator frequencies and check that (1) frequency is \pm 2% of set value and (2) frequency response is flat within 0.2 dB.

NOTE

The Model 1700A can be used to measure the ac voltage. If this is done, the drop in response at 10 Hz is caused by the characteristics of the voltmeter and not the oscillator.

<u>Multiplier</u>	<u>Digit*</u>	<u>Frequency</u>
X10	10	100 Hz
X1	10	10 Hz
X1	100	100 Hz
X100	100	10 kHz
X100	10	1 kHz
X1000	10	10 kHz

*Set remaining digits to 0.

3-10. Distortion Test

- a. Set FAST RESPONSE/LOW DISTORTION Switch to LOW DISTORTION and set ADJUST control to CAL.
- b. Measure distortion of oscillator at frequencies listed in Paragraph 3-9.

NOTE

The measurement technique for making oscillator distortion measurements (and the accuracy of the reading) depends on the type of test equipment available to the user. In general, this equipment will fall into the following three categories, listed below in order of measurement accuracy:

1. Model 1700A. In the absence of a wave analyzer, the Model 1700A can be used to make a rough check of the oscillator's distortion. Carry out the Distortion Test described in Paragraph 3-6.
2. Wave analyzer with a residual distortion of less than -60 dB. Set the Model 1700A to the 3V range and adjust the OSCILLATOR LEVEL control for a set level mark of -10 dB. Then use the wave analyzer to sort out the harmonic distortion products of the oscillator. This measurement is, in general, accurate to approximately .0005%.
3. Wave analyzer with a residual distortion of less than -80 dB. Set the oscillator output as described in 2 above. Connect a twin-T filter, which must attenuate the fundamental by at least 40 dB, ahead of the wave analyzer. Then use the wave analyzer to sort out the harmonic distortion products. This method is, in general, accurate to .0001% or 1 ppm. A suitable twin-T network for 1.06 kHz is shown in Figure 3-2.

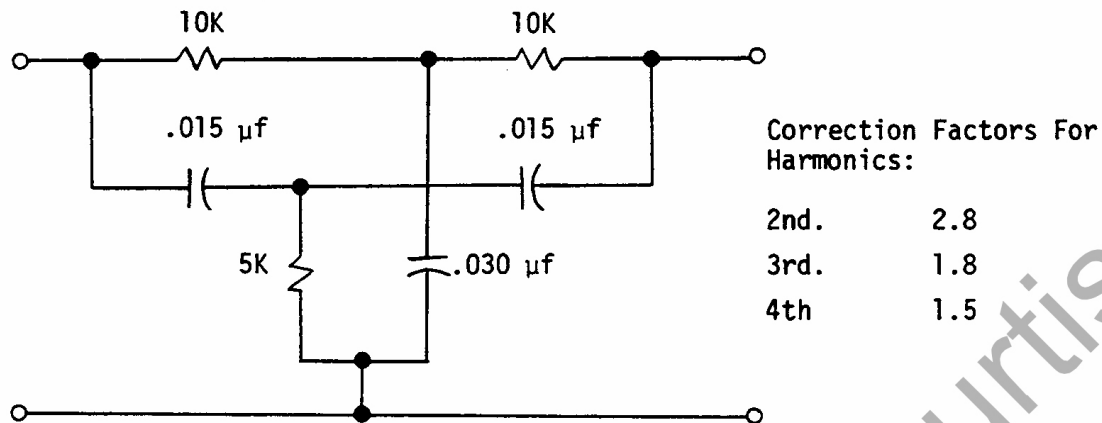

NOTE: All resistors are metal-film type, $\pm 1\%$ tolerance
 All capacitors are polystyrene type, $\pm 1\%$ tolerance

FIG. 3-2

3-11. DISTORTION ANALYZER CHECK

3-12. dB Volts Test

- a. Set Model 1700A controls as follows:

INPUT switch-----	30 V
OSCILLATOR LEVEL control-----	fully CCW
FAST RESPONSE/LOW DISTORTION switch-----	LOW DISTORTION
LOW DISTORTION switch-----	X10 = 1000 Hz
	100
RATIO switch-----	.01
SIGNAL COMMON switch-----	\nearrow

- b. Depress dB VOLTS pushbutton and adjust OSCILLATOR LEVEL control for full scale reading on meter.
- c. Set RATIO switch to next higher range and check that signal drops by approximately 10 dB.
- d. Again adjust OSCILLATOR LEVEL control for a full scale reading and then set RATIO switch to next higher range. Check that signal again drops by approximately 10 dB.
- e. Repeat this operation until a -10 dB reading on 10% range is reached. At this time, set OSCILLATOR LEVEL control fully clockwise and then rotate ADJUST control for a full scale reading.
- f. Set RATIO switch to 30% range and check that signal drops approximately 10 dB.

Rotate ADJUST control for full-scale reading. Set RATIO switch to 100% range. Check that signal drops approximately 10 dB.

3-13. Volts Power Test

- a. Set Model 1700A controls as follows:

INPUT switch-----	.003 V
ADJUST control-----	CAL
OSCILLATOR LEVEL control-----	fully CCW
FAST RESPONSE/LOW DISTORTION switch-----	FAST RESPONSE
FREQUENCY pushbuttons-----	X10 = 1000 Hz
	100
SIGNAL COMMON switch-----	

- b. Depress VOLTS POWER pushbutton and adjust OSCILLATOR LEVEL control until meter pointer indicates full scale.
- c. Set INPUT switch to next higher range and check that signal drops by approximately 10 dB.
- d. Again adjust OSCILLATOR LEVEL control for a full scale reading and then set INPUT switch to next higher range. Check that signal again drops by approximately 10 dB.
- e. Repeat this operation until 3 volt range is reached. At this time turn OSCILLATOR LEVEL control fully clockwise. Now up range INPUT switch through the remainder of its ranges, checking that signal drops by approximately 10 dB on each range.

3-14. Filters Test

- a. Set Model 1700A controls as follows:

INPUT switch-----	3 V
ADJUST control-----	CAL
OSCILLATOR LEVEL control-----	fully CW
FAST RESPONSE/LOW DISTORTION switch-----	LOW DISTORTION
FREQUENCY pushbuttons-----	X10 = 400 Hz
	40
RATIO switch-----	0 dB
SIGNAL COMMON switch-----	

- b. Depress dB VOLTS pushbutton and set ADJUST control for a 0 dB meter reading.
- c. Depress 400 Hz FILTERS pushbutton. Check meter for a -3 dB reading.
- d. Release 400 Hz FILTERS pushbutton.
- e. Set oscillator frequency to 80 kHz (depress X1000 and 80 pushbuttons) and depress 80 kHz FILTERS pushbutton. Check that signal attenuation is -3 dB or more.

3-15. Residual Noise Test

- a. Set Model 1700A controls as follows:

INPUT switch-----	3 V
ADJUST control-----	CAL
OSCILLATOR LEVEL control-----	fully CW
FAST RESPONSE/LOW DISTORTION switch-----	LOW DISTORTION
FREQUENCY pushbuttons-----	X10 = 1000 Hz 100
FILTERS pushbuttons-----	80 kHz
SIGNAL COMMON switch-----	\nearrow

- b. Depress SET LEVEL pushbutton and set ADJUST control until meter pointer is at SET LEVEL mark.
- c. Depress DISTORTION pushbutton and set RATIO switch to .01 range. (This reading is noise and distortion of oscillator and analyzer).
- d. Depress SET LEVEL pushbutton and adjust OSCILLATOR LEVEL control for a meter reading of -15 dB. (This greatly reduces the level of the signal input to the analyzer with the result that almost all of the distortion products are eliminated and only the residual noise of the analyzer remains).
- e. Depress DISTORTION pushbutton. Check that meter reading is less than .0025%.
- f. Remove cable connected between SIGNAL OUTPUT connector and INPUT terminals.
- g. Place a shorting link between INPUT terminals and connect to COM (∇) terminal.
- h. Depress dB VOLTS pushbutton and set controls as follows (meter full-scale sensitivity is now 30 μ V).

INPUT switch-----	.3 V
ADJUST control-----	CAL (fully CCW)
RATIO-----	.01%

- i. Depress 80 kHz FILTERS pushbutton and check that meter reading is less than 8 μ V.
- j. Release 80 kHz pushbutton and check that reading is less than 15 μ V.

3-16. Common Mode Rejection Test

- a. Connect SIGNAL OUTPUT BNC connector to INPUT terminals and set oscillator frequency to 60 Hz (depress X1 and 60 pushbuttons).
- b. Depress VOLTS POWER pushbutton and adjust OSCILLATOR LEVEL control for a meter reading of 1 volt.
- c. Remove cable from INPUT terminals and short + and - INPUT terminals together. Now connect input cable between - INPUT and GND (\nearrow) terminals.
- d. Set RATIO switch to -20 dB range and ADJUST control to CAL position.
- e. Depress dB VOLTS pushbutton. Check that meter reading is -20 dB or lower.

3-17. ADJUSTMENT and CALIBRATION PROCEDURE

The following is a complete adjustment and calibration procedure for the Model 1700A. The procedure should be carried out only when the Performance check (Paragraph 3-3) indicates that adjustments are required. If the Model 1700A does not meet the test limits specified in the following steps, consult the troubleshooting information provided in Paragraph 3-29. The location of the adjustment controls in the analyzer, oscillator, and power supply are shown in Figures 4-1, 4-3, and 4-6 respectively.

3-18. OSCILLATOR SECTION

3-19. +15 Volt Adjustment

- a. Connect HI lead of digital voltmeter (DVM) to +15 volt terminal and LO lead to GND terminal on power supply assembly.
- b. Adjust potentiometer R603 for DVM reading of +15.000, $\pm .010$ V.

3-20. Photocell AC Voltage Adjustment

- a. Set Model 1700A controls as follows:

FREQUENCY pushbutton-----X10 = 100 Hz
10
FAST RESPONSE/LOW DISTORTION switch----- FAST RESPONSE

- b. Connect HI lead of DVM to junction of R3 and R4; connect DVM LO lead to "0" terminal (oscillator output) on oscillator board.
- c. Adjust R5 for AC voltage reading of .20V.

NOTE

Clockwise rotation of R5 decreases voltage, counterclockwise rotation increases voltage.

3-21. Oscillator Integrator Voltage Change Adjustment

- a. Set Model 1700A controls as follows:

FREQUENCY pushbutton-----X10 = 100 Hz
10
FAST RESPONSE/LOW DISTORTION switch----- FAST RESPONSE

- b. Connect DVM HI lead to TP6 and LO lead to GND.
- c. Connect TP3 to GND with clip lead. Note dc voltage reading on DVM.
- d. Remove clip lead from TP3. Adjust potentiometer R7 for same dc voltage noted in Step c. $\pm .005$ V.

NOTE

The following is an alternative method of measuring the TP6 voltage with a floating VTVM:

Connect LO terminal of VTVM to positive terminal of C603 on power supply board and the HI terminal to TP6. (In this case, the dc potential at C603 is used as a bucking voltage so that the VTVM can be set to a lower (more sensitive) range to resolve the required 5 mV).

3-22. Oscillator Integrator Output Adjustment

CAUTION

If the photocoupler has been replaced, allow at least 10 minutes to elapse before proceeding with this adjustment. This is to allow the unit (and the technician!) to cool off after soldering.

SIGNAL COMMON switch-----	⏏ (ground)
FREQUENCY pushbuttons-----	X10 = 100 Hz
	10
OSCILLATOR LEVEL control-----	fully CW
LOW DISTORTION/FAST RESPONSE switch-----	LOW DISTORTION
FILTERS-----	80 kHz depressed

- b. Connect cable between SIGNAL OUTPUT connector and INPUT terminals.
- c. Connect one channel of oscilloscope to BUFFERED INPUT SIGNAL connector (at rear of instrument).
- d. Adjust oscilloscope so that waveform is synched to Buffered Input Signal.
- e. Monitor waveform at pin 6 of U312 with the other scope channel.
- f. Adjust R351 for minimum fundamental signal at pin 6 of U312.
- g. Now, monitor waveform at DISTORTION OUTPUT.
- h. Adjust potentiometers R337 and R354 until Distortion output waveform contains no fundamental signal.

3-26A. Phase Null Integrator Voltage Adjustment

- a. Set Model 1700A controls as described in Paragraph 3-6, Steps a. through d.
- b. Connect DVM HI lead to TP9 and LO lead to TP6.
- c. Adjust R364 for a dc voltage reading of 2.8V*.

*The 2.8V setting is for a dark adapted photocoupler. This is a photocoupler which has been in the off state for the last 24 hours (instrument power off). It is normal for the voltage at TP6 to gradually increase with time.

If the dc voltage between TP9 and TP6 is greater than 3.0 V after the instrument has been on for 24 hours or more, readjust R364 for 3.0 V.

3-27. Tuning Indicator Adjustment

a. Set Model 1700A controls as follows:

INPUT switch----- 3 V
 ADJUST control----- CAL (fully CCW)
 RATIO switch----- 1%
 FREQUENCY pushbuttons----- X10 (2nd. and 3rd. digits to zero)
 OSCILLATOR LEVEL control----- fully CW
 FAST RESPONSE/LOW DISTORTION----- FAST RESPONSE
 SIGNAL COMMON switch----- \uparrow (ground)

- b. Connect DVM LO lead to green wire connected to NOTCH FREQUENCY indicators and HI lead to junction of R320 and pin 6 of U305.
- c. Depress in turn each FREQUENCY 1st digit pushbutton and observe DVM voltage readings. Record (1) digit giving most positive reading and its value and (2) digit giving most negative reading and its value.
- d. Depress X1 Multiplier FREQUENCY pushbutton, and repeat procedure described in Step c.
- e. Depress X100 Multiplier FREQUENCY pushbutton and repeat procedure described in Step c.
- f. Review all readings recorded and determine (1) most positive value and (2) most negative value. Add these two values together (to determine voltage range) and then divide number by 2 (to determine mid-point).
- g. Depress digit previously determined to have most positive reading and adjust potentiometer R312 until DVM indicates mid-point value determined in Step f. See example below:

<u>Multiplier</u>	<u>Most Pos. Digit</u>	<u>Most Neg. Digit</u>
X10	60, + 1.0 V	50, + .20 V
X1	60, - .20 V	50, - .70 V
X100	60, + .01 V	50, - .60 V

Overall most positive = X10, 60 = + 1.0 V
 Overall most negative = X1, 50 = - .70 V
 Range = 1.70 V, mid-point = .85 V
 Adjust X10, 60 for + .85 V

- h. Depress X1000 Multiplier pushbutton and repeat Steps c. and f.
- i. Now depress digit giving most positive value and using a non-metallic screwdriver, adjust trimmer capacitor accessible through hole in shield on right-hand side of instrument for mid-point value determined in repeat of step f.

3-28. Calibration at 1 kHz

- a. Set Model 1700A controls as follows:

VOLTS POWER pushbutton-----	depressed
FILTERS-----	out
FREQUENCY pushbutton-----	X10 = 1 kHz
	100
INPUT switch-----	3 V
ADJUST control-----	CAL (fully CCW)
RATIO switch-----	.03%
SIGNAL COMMON switch-----	⌞ (ground)

- b. Set meter mechanical zeroing as described in Paragraph 1-12.
- c. Apply an accurate 3.162 V \pm 0.1% or better 1 kHz signal between +INPUT and -INPUT terminals. Connect low side of test signal to -INPUT.
- d. Connect chassis of precision ac source to GND (⌞) terminal on Model 1700A.
- e. Adjust Meter Sensitivity potentiometer R157 for an exact full-scale reading (1.0 mark on VOLTS scale) on meter.
- f. Depress SET LEVEL pushbutton. Adjust Set Level potentiometer R146 for an exact full-scale reading.
- g. Change input signal level to 1.000 mV. Depress dB VOLTS pushbutton and adjust Distortion Amplifier Gain potentiometer R237 for an exact full-scale reading.
- h. Change input signal level to .3162 mV and set RATIO switch to .01%. Adjust Distortion Amplifier Gain potentiometer R239 for an exact full-scale reading.

3-29. TROUBLESHOOTING

Check the two 3AG 1 Amp fuses located on bottom of instrument.

Before attempting to troubleshoot the Model 1700A, ensure that the fault is with the Model 1700A and not caused by the test setup or associated equipment. The Performance Check (Paragraph 3-3 enables this to be determined without having to remove the covers from the Model 1700A.

If an abnormal condition is observed during the Performance Check, Table 3-2 will suggest remedies. However, before proceeding with detailed troubleshooting, note the following suggestions:

- a. A good understanding of the principles of operation of the Model 1700A will assist the troubleshooter and it is recommended that the reader be familiar with the contents of Section II of this manual.
- b. Any suspected malfunction should first be tested with the Performance Check. This need not be carried out in its entirety ---- only the portion applicable to the suspected malfunction need be performed.
- c. Verify proper power supply operation by measuring the +15 Vdc and -15 Vdc voltages. Check also the +12, -6 and -8 Vdc supplies which operate the null control circuits on the analyzer board.
- d. Many measurement problems or bad readings can be related to incorrect grounding. Refer to Paragraph 1-8 for correct grounding instructions.
- e. The differential input circuitry of the Model 1700A requires a return to circuit common. Check the input cabling for proper connections.
- f. Attempt to isolate the malfunction to either the oscillator or the distortion analyzer. After this, try to isolate the fault to a circuit block within the suspected unit.

- g. Determine component failure within the analyzer by operating the Model 1700A without an input signal and then comparing dc levels with those marked on the schematic.
- h. Since the instrument contains a number of identical components mounted in plug-in sockets, it is permissible to switch these units in order to isolate a malfunction. However, known good components must always be returned to their original locations.
- i. Phase detector U303 in the tuning indicator need not be in position for proper notch filter operation. This component can therefore be used to isolate a malfunction in the null control circuits. But be sure to return the original I.C. to U303 when done.
- j. Abnormally large potentials (more than ± 15 mV) measured between the + and - input terminals on operational amplifiers generally indicate a defective amplifier.
- k. When a malfunction occurs try first to find out if the trouble relates to any particular pushbutton. If it does, it may be possible to cure the problem by depressing and releasing the defective button several times.

3-30. SYMPTOM/CAUSE TABLE

Table 3-2 contains symptoms of Model 1700A malfunctions and provides diagnostic tests for the location of these faults. Before beginning detailed troubleshooting, the reader is advised to study notes a. through k. in Paragraph 3-29.

Following the replacement of a defective component, refer to Paragraph 3-31 for instructions regarding any necessary calibration and/or adjustment procedures.

3-31. COMPONENT REPLACEMENT - CALIBRATION and ADJUSTMENT

Portions of the Model 1700A Adjustment and Calibration Procedure (Paragraphs 3-18) and other adjustments must be completed following the replacement of certain components in the instrument. These components, and the applicable Adjustment/Calibration Procedures are as listed below:

<u>Component</u>	<u>Required Adjustment/Calibration Procedure</u>
a. Photocoupler U7 (Oscillator)	Oscillator Integrator Output Adjustment (Paragraph 3-22)
b. Voltage - controlled resistor Q1 (Oscillator)	Oscillator Integrator Voltage Change Adjustment (Paragraph 3-21)
c. Operational Amplifier U1 (Oscillator)	Oscillator X1000 Frequency Range Adjustment (Paragraph 3-23)
d. Operational Amplifiers 2605, 2625 (Analyzer)	DC Zero Adjustment - related adjustment (Paragraph 3-25)
e. Meter M1 (Analyzer)	Calibration at 1 kHz (Paragraph 3-28)
f. Phase detectors U307, U310 (Analyzer, null control)	Null Adjustment (Paragraph 3-26)
g. Phase detector U303 (Analyzer, tuning Indicator)	Tuning Indicator Adjustment (Paragraph 3-27)
h. Photocoupler U205 (Analyzer, phase null control)	Allow 10 minutes for the photocoupler to cool off after soldering. Phase Null Integrator Voltage Adjustment (Paragraph 3-26A).

- i. Photocoupler U206
(Analyzer, amplitude
null control)
- Allow 10 minutes for the photocoupler to cool off after soldering. Set controls as described above. Connect DVM HI lead to TP8 and LO lead to TP7. Reading is dc voltage across R359. Calculate current through it. If necessary, select new value for R359, such that $1.4 \pm .2$ V is developed across it. Replace R359.

3-32. REPLACEMENT and REPAIR

3-33. SPECIAL PRECAUTIONS

3-34. Contamination

The performance of the Model 1700A will be greatly degraded by contamination of the circuit-board surfaces or components. Finger marks and oil droplets are contaminants to be especially avoided. To minimize the possibility of contamination, observe the following precautions:

- a. Do not disassemble any portion of the Model 1700A unless absolutely necessary (for example, to replace relays on oscillator board or to service frequency modules.)
- b. Avoid any unnecessary handling of the printed-circuit boards or components. Replace components from the top side of the boards only.
- c. Employ only the soldering and component replacement techniques described in Paragraphs 3-36 through 3-39.

3-35. WIRING

Lead dress within the instrument should not be altered. This is especially important with the wires running between the rotary switches and the distortion analyzer assembly. Before removing an assembly with wires attached, make a sketch showing the exact arrangement of the wires so that they may be replaced in the same manner.

3-36. SOLDERING TECHNIQUES

- a. Use a low-wattage iron with a pencil-shaped tip and allow it to reach full operating temperature before use. A fully-heated iron ensures the quick completion of soldering and minimizes the chance that the etched wiring on the printed-circuit boards will be damaged by excessive heat.
- b. Before using the soldering iron, wipe it off to remove excess solder and oxide.
- c. Use only a solder with non-corrosive non-conductive flux. Do not use acid-cored solder.
- d. Do not clean off the rosin around the soldered joint with a wire brush or metal scribe. This will destroy the high electrical resistance of the board.

3-37. COMPONENT REPLACEMENT

CAUTION

The use of Soder-Wick* (rosin-impregnated copper braid) or a similar product is highly recommended for the removal of solder during the de-soldering operation. If it is not available, and a vacuum-type de-soldering tool is employed, ensure that it is cleaned before use. This is to prevent the possibility of conductive debris being sprayed on the board during the de-soldering process.

*Soder-Wick may be obtained from Solder Removal Company, Covina, CA, U.S.A.

Table 3-2

SYMPTOM	PROBABLE CAUSE	DIAGNOSTIC TEST
Oscillator will not settle down to low distortion mode	Photo-coupler, U7 VCR, Q1 R7 out of adjustment Dual Timer, U6 Oscillator amp. U1	Replace photo-coupler Replace VCR Do oscillator Integrator Change Adjustment (Paragraph 3-21) Replace U6 Replace U1
Oscillator has excessive unstable distortion readings	Photo-coupler, U7 VCR, Q1 Oscillator amp., U1	Replace U7 Replace Q1 Replace U1
Oscillator has excessive third harmonic distortion	Photo-coupler, U7	Replace U7
Oscillator produces clipped waveforms	Photo-coupler, U7 RC filter amplifier, U2 Integrator Amplifier, U3 Oscillator Amp., U1 Peak detectors, Q2, Q3	Replace U7 Replace U2 Replace U3 Replace U1 Replace Q2 or Q3
Oscillator has no output on all frequencies	Oscillator Amp., U1	Replace U1
Oscillator has hum output	Improper ground connections or Float switch set to ground (A) position	Check that ground and signal connections are in compliance with Paragraphs 1-8 and 1-9
Hum in distortion output	Missing chassis connection between 1700A and scope	Check that connections are in compliance with Paragraphs 1-8 and 1-9
Distortion reading contains excessive hum	Missing ground return for 1700A differential front end	Check that connections are in compliance with Paragraphs 1-8 and 1-9
High distortion reading under all conditions (Not Nulling)	Amplitude Null Circuit (U302, U310, U311, U312)	Check D.C. voltages on Null circuit without input signal
	Photo-coupler, U206	Replace U206
	Phase Null Circuit (U306, U307, U308, U309)	Check D.C. voltages on Null circuit without input signal
	Photo-coupler, U205	Replace U205

Table 3-2, Continued

SYMPTOM	PROBABLE CAUSE	DIAGNOSTIC TEST
High distortion reading under all conditions (Not Nulling), Cont.	Notch Filter (U201, U202, U203, U301)	Open feedback loop by lifting up one end of R203 (100 ohms). Check D.C. voltages on Notch Filter circuit without input signal
One of Notch frequency lights stays ON during measurement on all frequencies	Leaky zener diode CR304 or CR305 Tuning indicator circuit (U303, U304, U305) Phase detector, U303 R312 out of adjustment	Disconnect zener from circuit while operating in Distortion Function Check D.C. voltages on circuit without input signal Replace U303 Do tuning indicator adjustment (Paragraph 3-27)
Analyzer has excessive unstable distortion readings	Photo-coupler U205 or U206	Make certain the symptom is from the analyzer section and not the oscillator section. Then replace U205 or U206
One of notch frequency lights stays ON during distortion measurement on some frequencies	Oscillator frequency drifted out of $\pm 2\%$ limit R312 out of adjustment Range capacitor(s) or digit resistor(s) drifted out of tolerance in analyzer section	Check oscillator frequency with counter Do tuning indicator adjustment (Paragraph 3-27) Unsolder range capacitor(s) from P.C. board to measure value. Check the suspected resistor(s) by actuating proper pushbutton(s) and measure at analyzer P.C. board.
Nulling becomes excessively slow	Oscillator drifted up in frequency Photocoupler U205 or U206 characteristic changed causing a high integrator voltage	Check frequency with counter Do Phase Null Integrator Voltage Adjustment (Paragraph 3-26A). Check D.C. voltage at TP8 with respect to TP7. If voltage is greater than 6 volts, change R359 according to procedure described in 3-31-i. If new R359 ≤ 500 ohms, change U206.
Not Nulling on some frequencies	Bad contact in pushbutton switch	Refer to Troubleshooting Paragraph 3-29-k

3-38. Multi-Lead Devices

Follow the instructions given below when replacing multi-lead components on the printed-circuit boards:

- a. Cut all leads to remove device from P.C. board. The pieces of the leads that remain can then be unsoldered from the board.

CAUTION

Be sure to hold each lead with needle-nose pliers when it is unsoldered. This is to prevent the possibility of a lead dropping through a hole and shorting traces below the board.

- b. Using Solder-Wick, remove remaining solder from component holes.
- c. When replacing a device, ensure that the length of its leads match the length of the leads on the device removed. Do not push the new device too far down into board as this may cause a short to the metal deck below. The clearance between the boards and the metal deck is 1/4 inch.

3-39. Potentiometers

The small black rectangular potentiometers are attached to the printed-circuit boards by three leads projecting from their lower surface in line with the numbers "1", "2", and "3" marked on top. To remove this type of potentiometer, proceed as follows:

- a. Carefully raise side of potentiometer opposite numbers until leads below are visible.
- b. Continue bending leads until there is sufficient clearance for tip of soldering iron.
- c. Unsolder potentiometer following instructions given in Paragraph 3-38.
- d. Install replacement component following reverse procedure.

3-40. Power Supply

The majority of the components on the power supply assembly may be replaced without removing the board from its location on the rear panel. However, if additional access is required proceed as follows:

- a. Remove bottom cover from Model 1700A and remove retaining screws securing power supply board to rear panel.
- b. Slide power supply board forward through bottom of instrument as far as wires attached to it will allow.

3-41. FREQUENCY MODULE REPAIR

3-42. General

The following procedure details step by step instructions for disassembly and repair of the instrument's frequency module. It is recommended that this procedure be closely followed and performed only by personnel familiar with electronic equipment disassembly/assembly techniques.

3-43. Removal/Replacement

CAUTION

Certain subassemblies in the instrument are secured with hardware which includes insulating washers. Note the location of these washers when disassembling the unit and replace them in the same locations on reassembly. Failure to observe this precaution will result in improper operation of the instrument.

- a. Remove top and bottom covers and place instrument on clean work surface.
- b. Remove four screws securing right side brace (side nearest power transformer) to front and rear panels.
- c. Remove three screws securing deck and switch bracket in the bottom channel of right side brace.
- d. Remove handle caps and two screws securing handle to right side brace.
- e. Remove two screws securing analyzer deck to rear panel.
- f. Remove two screws securing left side brace to rear panel.
- g. Pull back rear panel and slide out brown handle plate on right side brace.
- h. Remove screw (which was beneath brown handle plate) securing switch bracket to right side brace.
- i. Remove four screws securing power supply assembly to rear panel. Move power supply to allow access to oscillator deck screws.
- j. Remove two screws securing oscillator deck to center divider.
- k. Remove two screws securing switch bracket to center divider.
- l. Carefully withdraw oscillator portion of frequency module from instrument. Unsolder wires attached to assembly if complete removal is desired.

NOTE

The wires are color-coded for attachment to the numbered holes in the printed circuit board; black = 0, brown = 1, red = 2, orange = 3, yellow = 4, etc.

- m. Remove four nuts securing analyzer portion of frequency module to front panel. Slide assembly back for access and unsolder wires if complete removal is required.
- n. Replace analyzer and oscillator frequency module assemblies and reassemble instrument following reverse procedure.

NOTE

1. When replacing analyzer portion of frequency module, line up pushbuttons with openings in front panel.

2. When replacing oscillator portion of frequency module, line up pushbars vertically with the rear of the pushbars of the analyzer section. Ensure also that there is a .015 inch clearance between the analyzer and oscillator pushbars, with the pushbuttons in undepressed position. See Figure 3-2 for details.

3-44. Repair Instructions

CAUTION

Field repair of the frequency module is limited to replacement of defective RC components on the switch boards. Replacement of pushbutton switches is not recommended -- order a replacement switch board from the factory.

- a. Remove bus wires running between boards, using multi-lead component desoldering technique described in this section of the manual. (paragraph 3-38)
- b. Detach board containing defective components from switch bracket and replace component.
- c. Reassemble module, replacing bus wires removed in step a.

NOTE

1. Spacing between boards must be $25/32$ inch (inside to inside dimension) to ensure proper alignment.
2. Boards must be perpendicular to switch mounting bracket.

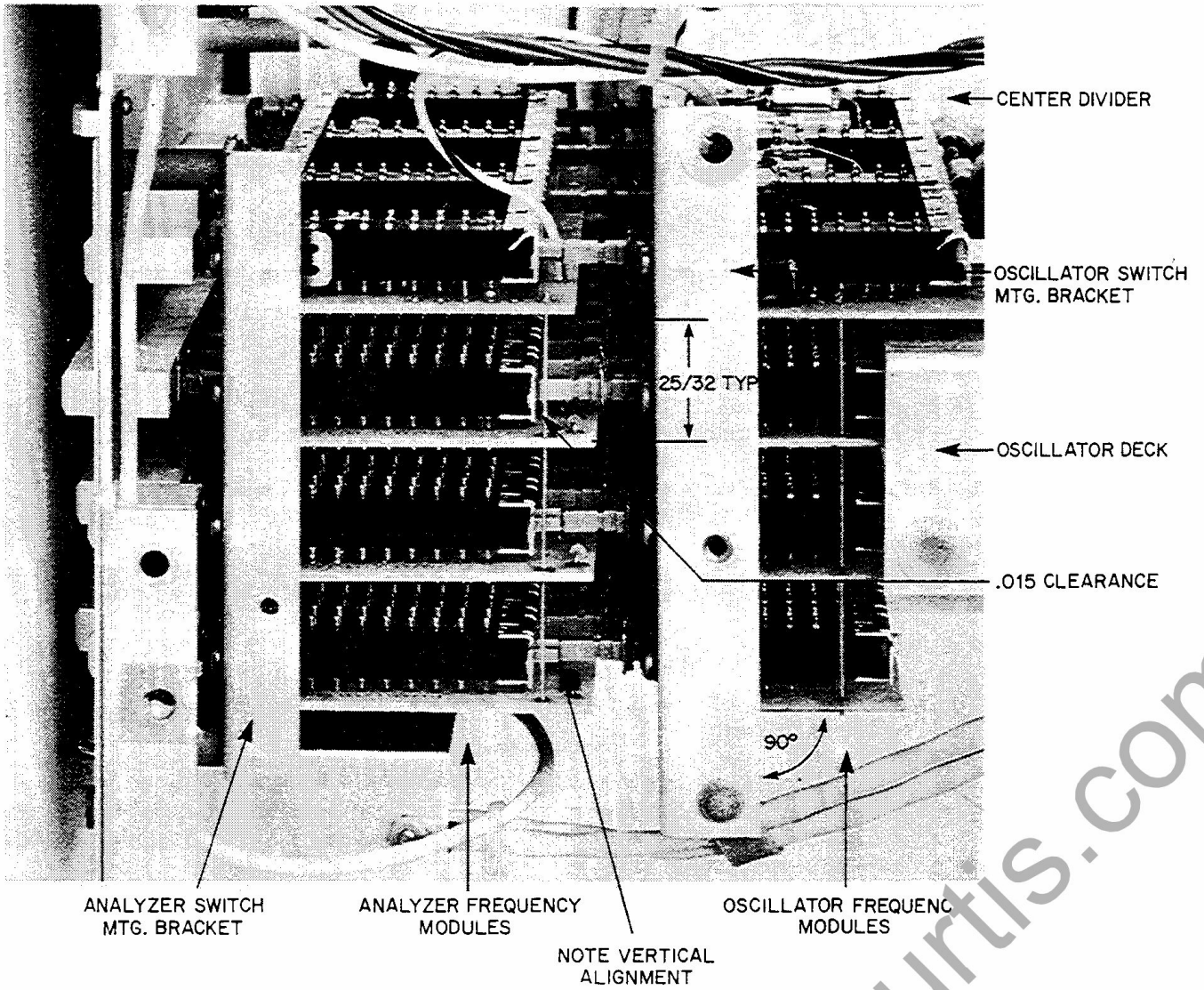

FIG. 3-2

SECTION IV DIAGRAMS

4-1. INTRODUCTION

This section contains the circuit diagrams necessary for the operation and maintenance of the Model 1700A. Included are schematic diagrams and component location diagrams.

4-2. SCHEMATIC DIAGRAMS

The circuitry contained within each assembly is shown in the schematic diagrams. As an aid to isolating malfunctions, the diagrams also provide typical operating voltages and wave-forms.

4-3. COMPONENT LOCATION DIAGRAMS

The component location diagrams show the physical location of parts mounted on each assembly. Each part is identified by a reference designator, similarly identified on the schematic diagrams and in the parts list.

www.stancurtis.com

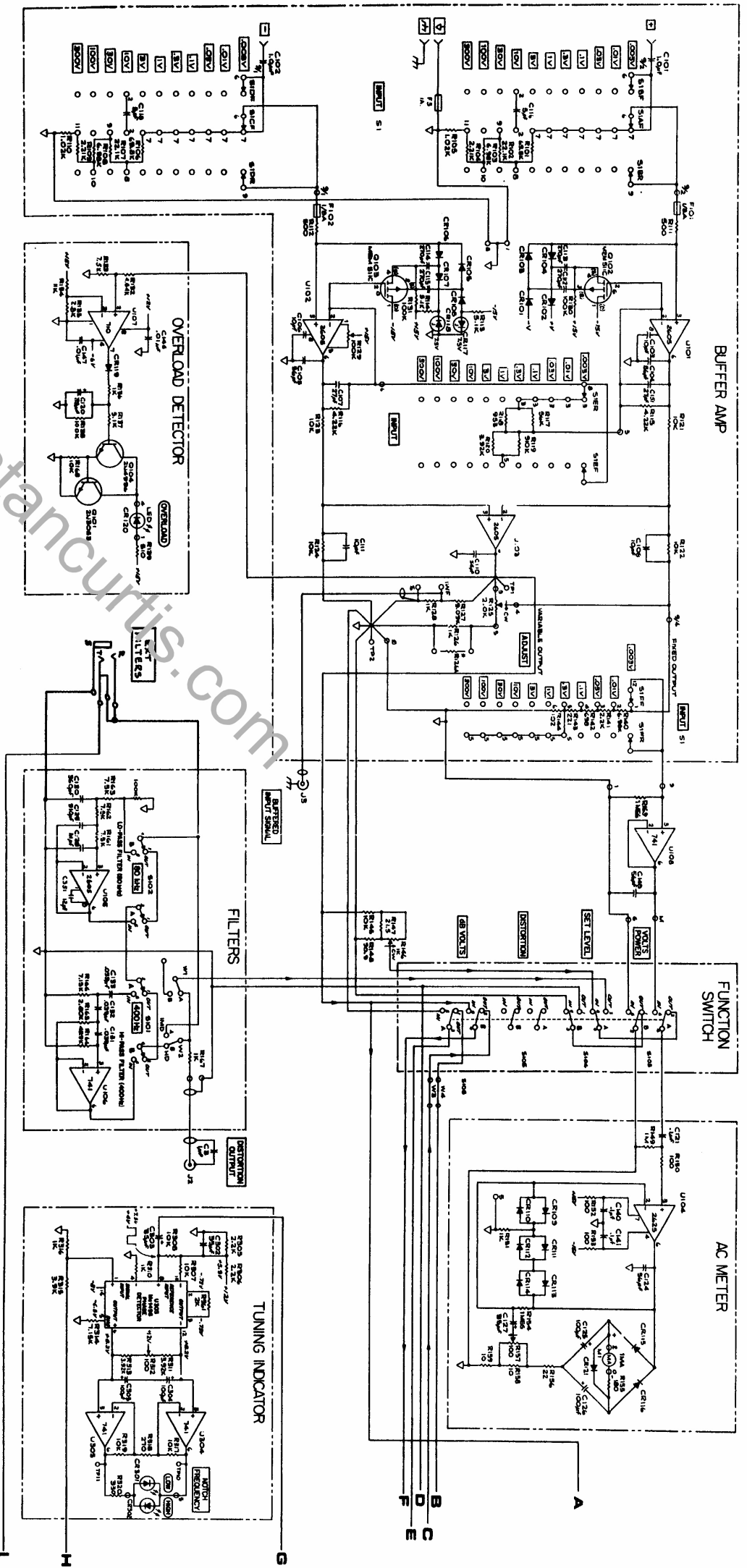

FIGURE 4-2
 SCHEMATIC DIAGRAM
 1700 DISTORTION MEASUREMENT SYSTEM

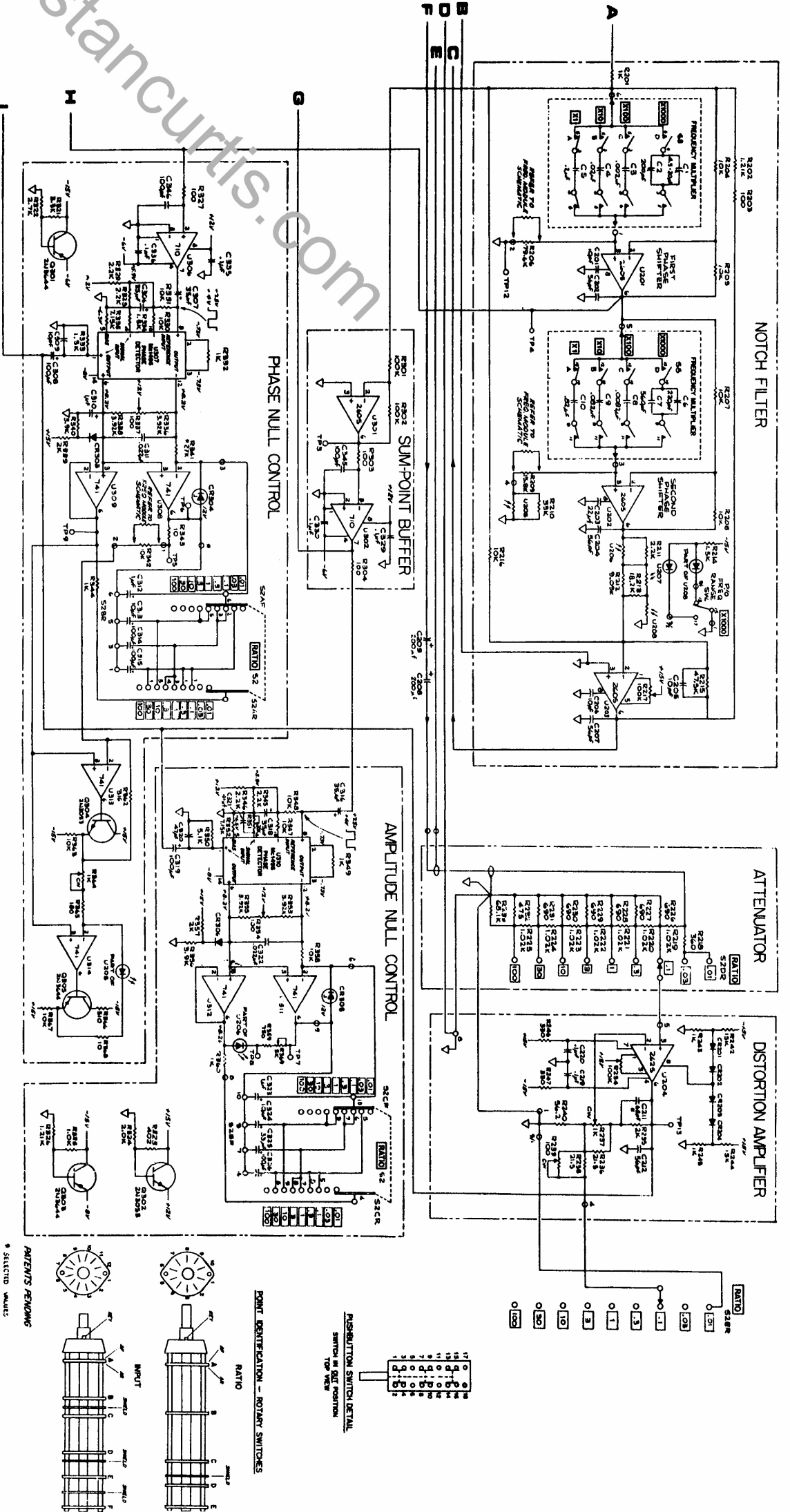

FIGURE 4-2 (CONTINUED)
SCHEMATIC DIAGRAM
1700B DISTORTION MEASUREMENT SYSTEM

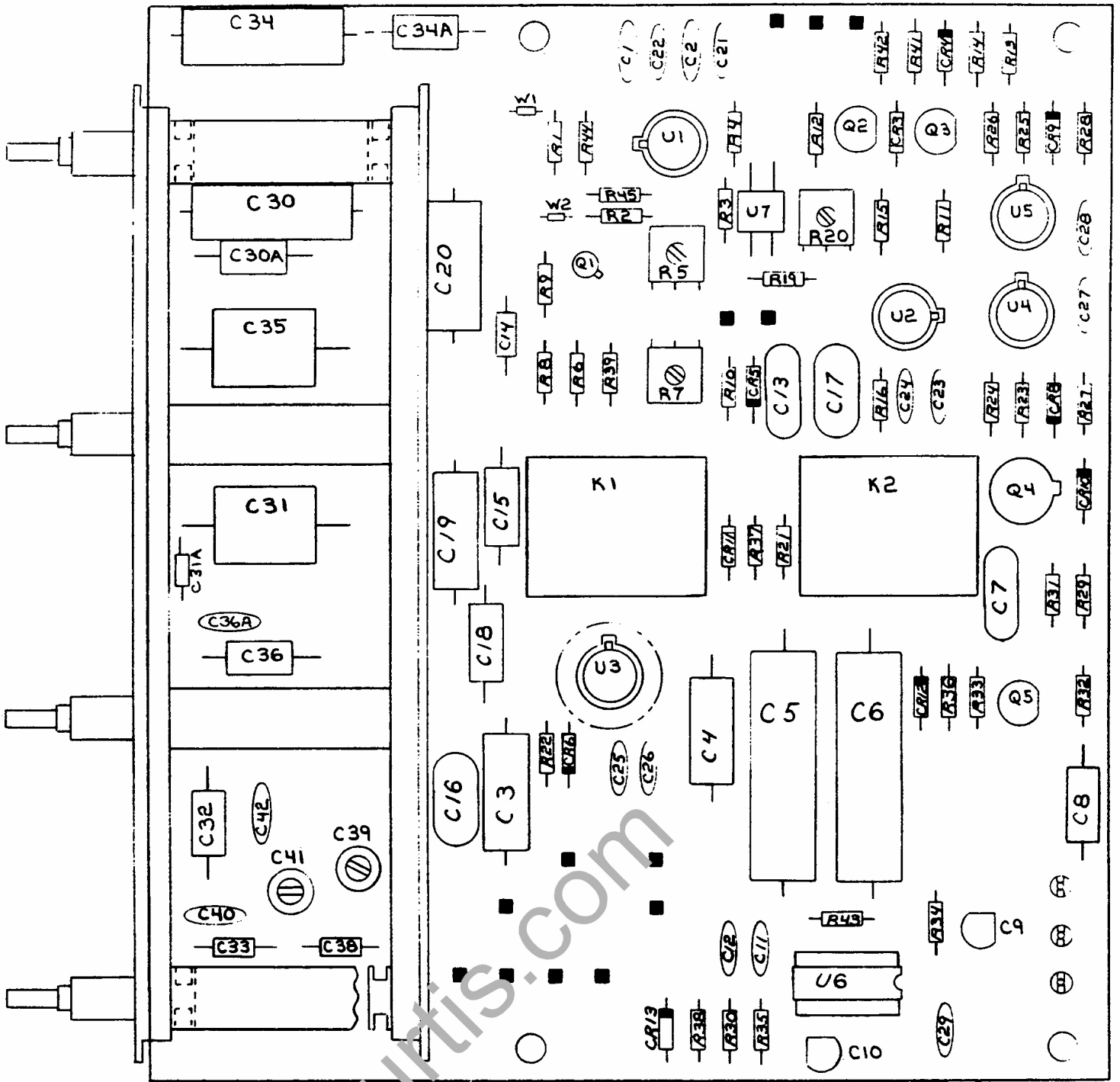

FIGURE 4-3
COMPONENT LOCATOR
OSCILLATOR BOARD

www.stancurtis.com

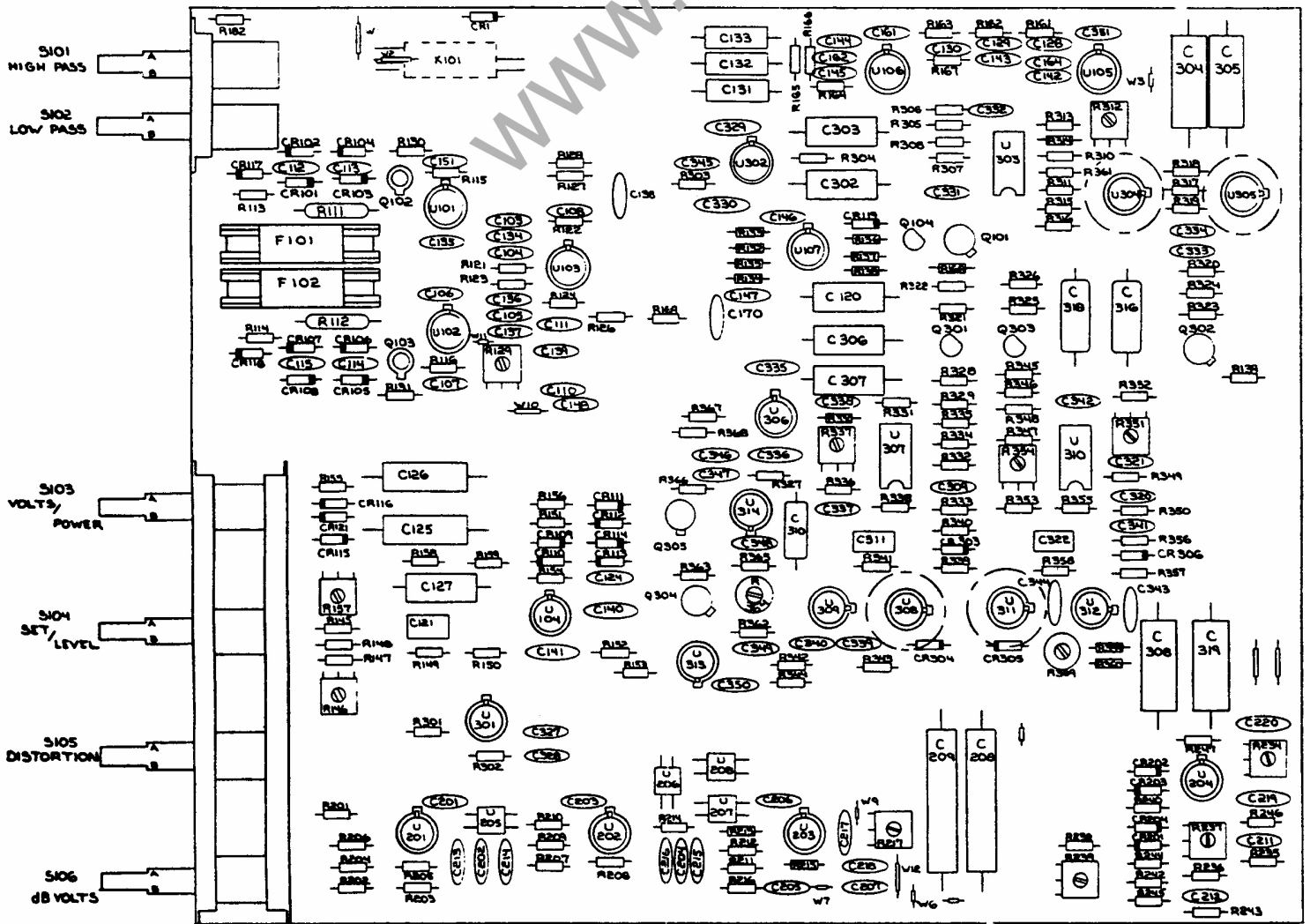
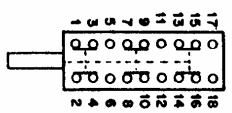
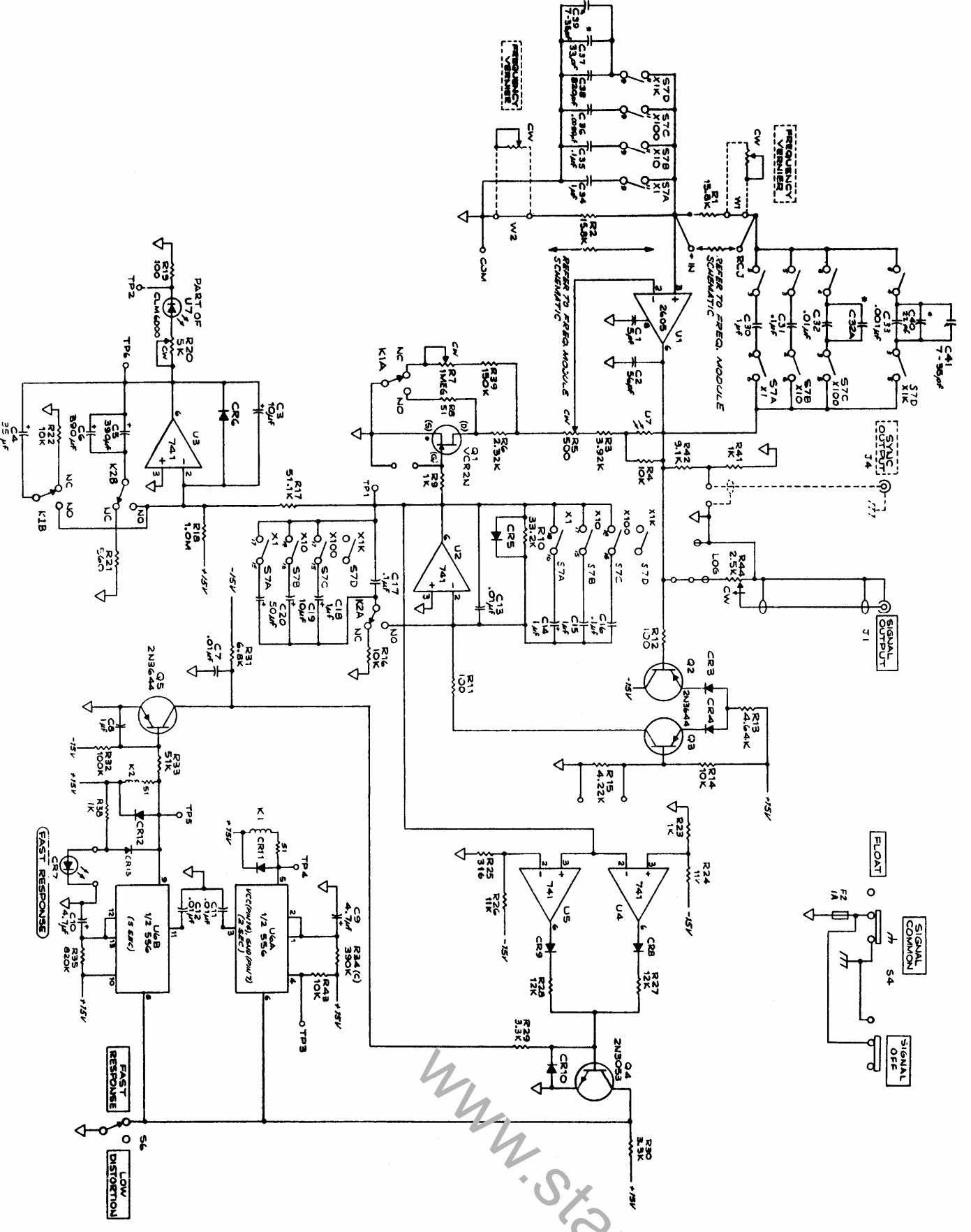

FIGURE 4-1 (DUPLICATE)
COMPONENT LOCATOR
ANALYZER BOARD



PUSHBUTTON SWITCH DETAIL
SWITCH IN OFF POSITION
TOP VIEW

* SELECTED VALUE

FIGURE 4-4
SCHEMATIC DIAGRAM
OSCILLATOR BOARD

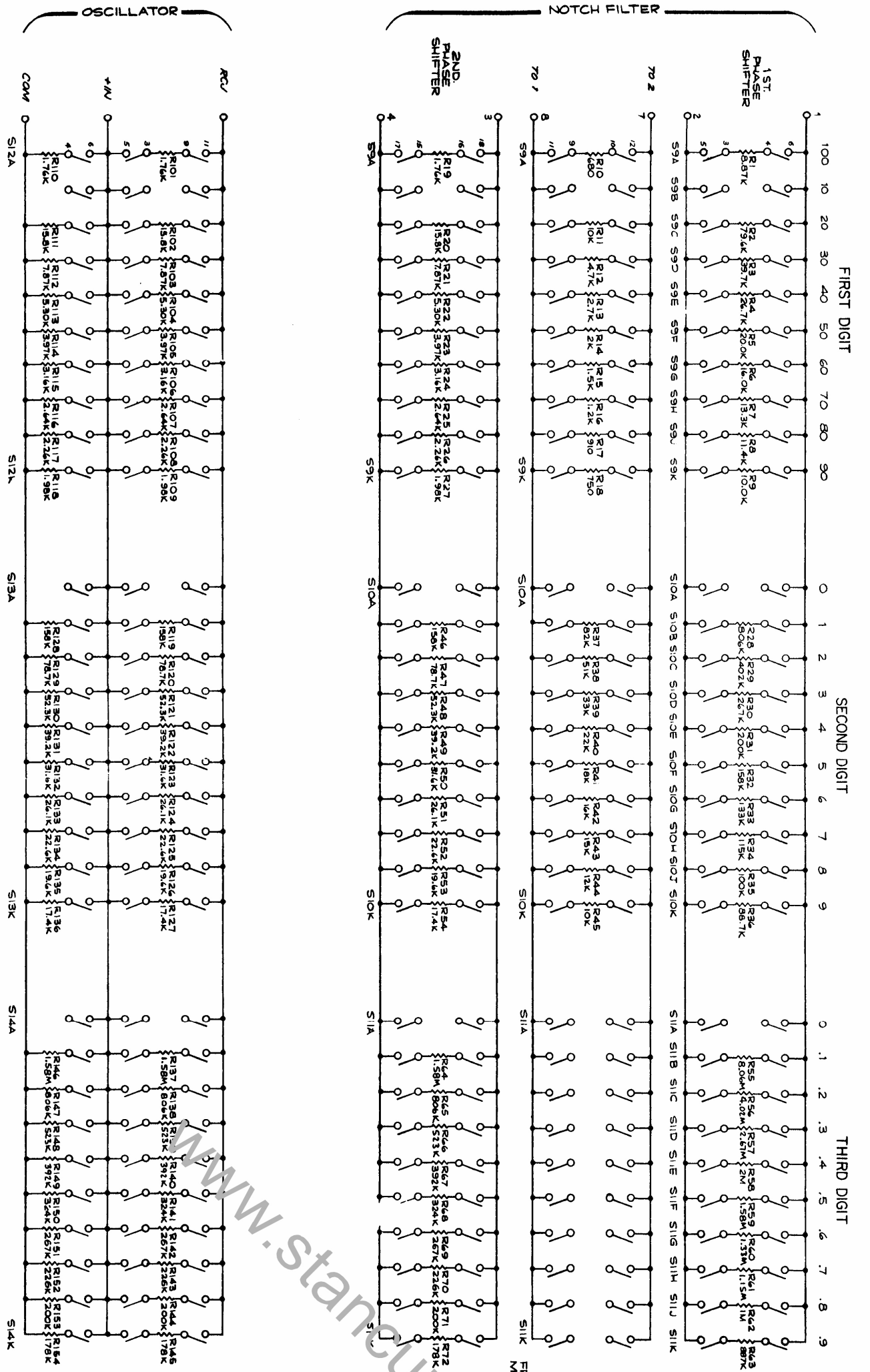

FIGURE 4-5
SCHEMATIC DIAGRAM
FREQUENCY MODULES

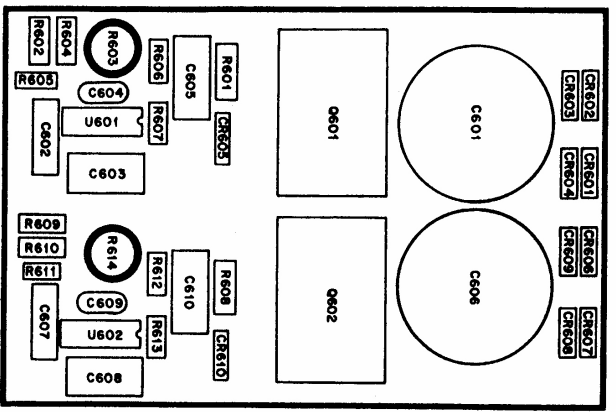

FIGURE 4-6
COMPONENT LOCATOR
POWER SUPPLY BOARD

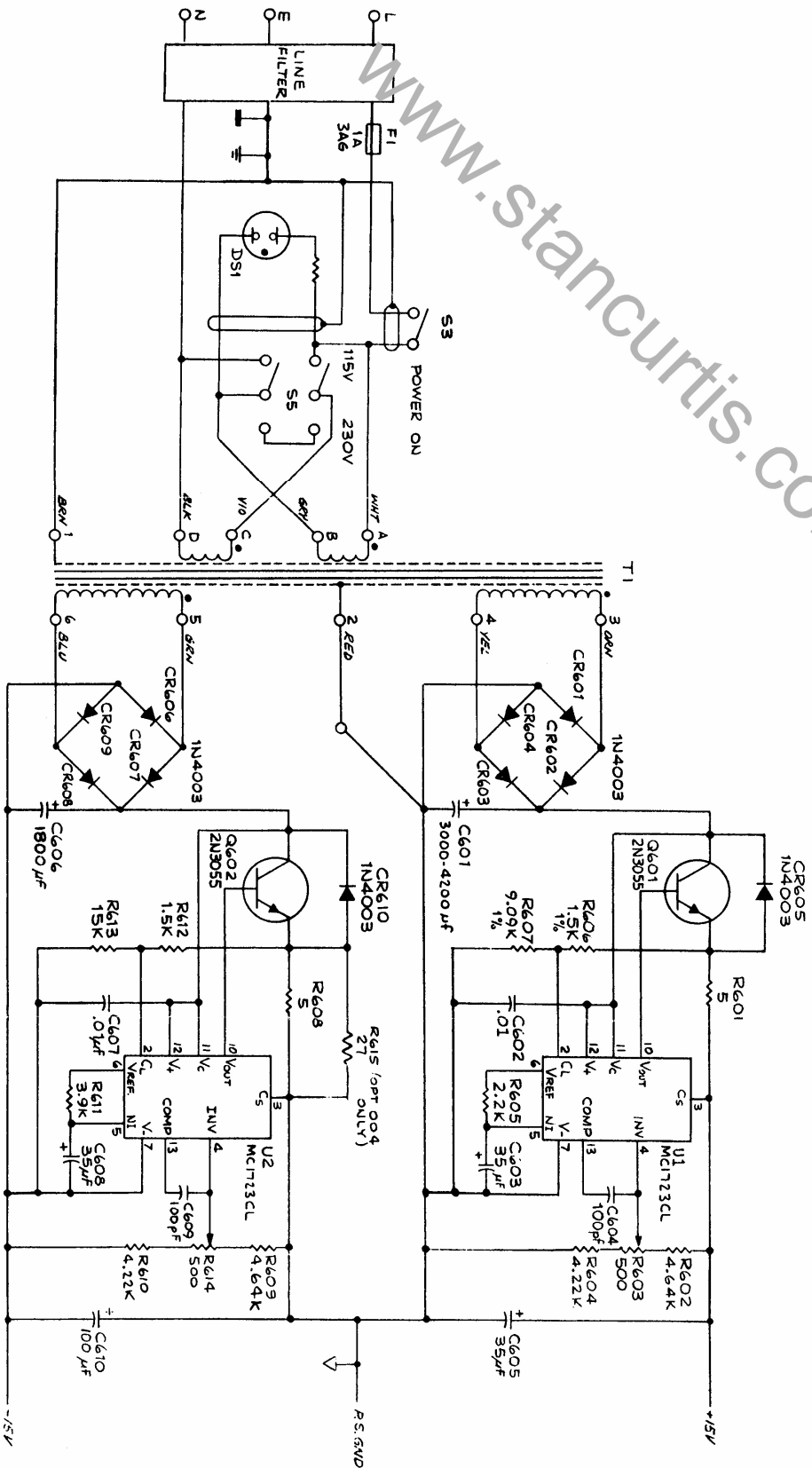

FIGURE 4-7
SCHEMATIC DIAGRAM
POWER SUPPLY BOARD

SECTION V - SPARE PARTS

5-1. INTRODUCTION

This section contains information for ordering replacement parts, and provides the following details:

- a. The Sound Technology part number.
- b. Circuit diagram reference designator.
- c. General description of part.
- d. Total quantities used.

5-2. ORDERING INFORMATION

When ordering replacement parts, each part must be identified by a Sound Technology part number. To order a part include the following information:

- a. Instrument model number.
- b. Instrument serial number.
- c. Description of part.
- d. Function and location of part.

Address your order or inquiry to:

Sound Technology
1400 Dell Avenue
Campbell, California 95008

(408) 378-6540

5-3. PARTS LIST

PART NO	DESCRIPTION
0300-0000	DIODE-LED RED CR7, 120, 301, 302
1400-0002	RES-VAR 2.5K 10% 2W LOG CARB R44
1400-0009	RES-VAR 2K 10% 2W SPST SWITCH R125
2020-0004	CAP-FXD 1UF 10% 100V TUBULAR C3
2020-0005	CAP-FXD 1UF 10% 400V TUBULAR C101, 102
2040-0001	CAP-FXD 0.01UF 2KV CERAMIC C1, 2
3000-0001	SWITCH-TOGGLE S3
3005-0000	SWITCH-SLIDE DPDT S6
3005-0001	SWITCH-SLIDE, LINE SELECT S5
3100-0000	CONNECTOR-BNC JACK, SHORT
3100-0001	CONNECTOR-BNC JACK, LONG
3110-0000	CONNECTOR-AC RECEPTACLE
3110-0001	CONNECTOR-BINDING POST, BROWN
3200-0002	TRANSFORMER-POWER 1700A T1
3200-0003	END CAP, LARGE-XFMR
3320-0000	METER-1MA, VRMS, PWR, DB M1
3440-0000	LAMP-NEON, AMBER DS1
3445-0001	CONNECTOR-LAMP
3445-0002	RETAINING CLIP-LAMP
3480-0002	FUSE-1 AMP, 3AG F1-3
3485-0000	FUSE HOLDER, 3AG
3485-0003	FUSE HOLDER-DOUBLE, SCREW MOUNT

OPTION 003

AUTOMATIC SET LEVEL

OPERATING PROCEDURE

- a. Complete normal signal connections to the amplifier under test as described on page 1-3 of 1700A Manual.
- b. Rotate the ADJUST Control fully counter-clock wise, past the CAL position, until a click is heard. This activates the auto-set-level circuitry.
- c. Select VOLTS/POWER function and adjust INPUT range switch so that the voltage (or power) reading is obtained with the meter pointer in the upper two-thirds of meter scale. (Levels lower than 1/3 and much greater than full-scale will cause errors in distortion readings.)
- d. Select DISTORTION function and take the distortion reading in the usual manner.

NOTE

1. The overload light will glow whenever the VOLTS/POWER meter is being overloaded by more than 10% during distortion measurements. It is meant to inform the operator to up-range (advance the INPUT switch) while monitoring the distortion figure.

NOTE

2. It is normal for the residual noise to increase slightly with the Auto-Set-Level circuit in operation. The error in distortion reading due to this noise is, in general, insignificant when the distortion figure is .02% or greater.

TROUBLE-SHOOTING

The Auto-Set-Level circuit is an open-loop type, so straight-forward signal tracing techniques can be used to locate defective parts. The entire circuit block is always active, even in the manual mode.

With full-scale output at the Buffer Amplifier, the Multiplier should have unity gain. With .316 of full-scale Buffer output, the Multiplier gain should change to 3.16.

PRINCIPLES OF OPERATION

The signal input to the Notch Filter (or the variable output of Buffer) is fed to the AC to DC Converter (U1, U2). The DC signal out of this converter, which is directly proportional to the Notch Filter input signal level, is in turn driving a Voltage to Current Converter (U3), which regulates the controlling current to the Multiplier. The Multiplier is used as a variable gain amplifier (gain range from 1 to 3.16). Its gain is inversely proportional to the controlling current and the magnitude of the AC signal to the Notch Filter.

In the manual distortion-measurement mode, whenever the input signal is below full-scale (but more than 1/3 on VOLTS scale), Buffer Amplifier gain has to be increased with the use of the ADJUST control to make up for the lower amplitude. In the automatic mode, the distortion signal level is increased to exactly the required amount through the Multiplier before it goes to the AC meter. The net effect is the same as increasing the Buffer Amplifier gain, and the distortion readings obtained in this manner will always be accurate.

Since the Multiplier is precessing signals after the Notch Filter, it is not adding distortion to the signal being analyzed. As a matter of fact, this scheme actually reduces the residual distortion noticeably above 50 kHz when the input signal is significantly below full-scale. However, there is some degradation of signal-to-noise ratio whenever the Notch Filter is operating with a smaller signal.

PERFORMANCE CHECK FOR
AUTO-SET-LEVEL OPTION

a. Connect cable between SIGNAL OUTPUT BNC connector and INPUT terminals.

b. Set Model 1700A controls as follows:

SIGNAL COMMON switch	
INPUT switch	1V
ADJUST control	CAL
FUNCTION	VOLTS/POWER
FAST RESPONSE/LOW DISTORTION Switch	FAST RESPONSE
FREQUENCY pushbuttons	X100, 10 (1 kHz)
FILTERS pushbuttons	80 kHz

c. Adjust OSCILLATOR LEVEL control for .95V rms as indicated on meter.

d. Depress SET LEVEL pushbutton and rotate ADJUST control until meter pointer is exactly over SET LEVEL mark.

e. Depress DISTORTION pushbutton and set RATIO switch to proper range (.03% or .1%) to obtain a good reading (meter pointer in upper 2/3's of meter scale). Note this distortion reading.

f. Now, rotate the ADJUST control counter-clockwise until a "click" is heard. (• AUTO position).

g. Note distortion reading on meter. This reading should be the same as the one noted in step e with an error no greater than 2 minor divisions on the 0-1 scale.

h. Change INPUT switch to 3V range (set level is now reduced by 10 dB) and note distortion reading on meter. This reading should be the same as the one noted in step e with an error no greater than 2 minor division on the 0-1 scale.

i. Set FREQUENCY pushbuttons to X1000, 100 (100 kHz) and OSCILLATOR LEVEL control fully CW (Maximum output).

- j. With 80 kHz FILTER turned off, manually SET LEVEL to obtain distortion reading. Note this reading on dB meter scale.
- k. Rotate the ADJUST control counter-clockwise until a "click" is heard. Note the distortion reading on dB meter scale. This reading should agree with the one obtained in step j within 1 dB.

NOTE

It is normal for the distortion reading to drop when the input signal is reduced 10 dB below set level mark at 100 kHz. This is because the residual distortion of the analyzer has been greatly reduced with the decrease in input level at 100 kHz. (A bonus benefit from the Auto-Set-Level Option).

- l. Depress VOLTS/POWER function switch, change INPUT switch to 1V, and change Oscillator frequency to X100, 10 (1kHz). Decrease OSCILLATOR LEVEL control rapidly until OVERLOAD indicator is extinguished. Then increase OSCILLATOR LEVEL very slowly until OVERLOAD indicator just begins to glow (adjust control back and forth if necessary to find the point at which indicator just starts to light).
- m. Now change INPUT switch to the 3V position and note meter reading. Meter pointer should be between -9.5 and -8.5 on dB scale (106 and 118 on 0-3V scale).

CALIBRATION PROCEDURE FOR
1700A AUTOMATIC SET-LEVEL OPTION

- a. Center all four trim-pots on Auto-Set-Level PC board and turn power on.
- b. Connect oscillator SIGNAL OUTPUT to analyzer INPUT.
- c. Set 1700A controls to:

INPUT switch	300V
FUNCTION	SET-LEVEL
ADJUST control	CAL (Max. CCW-Just before click)
RATIO switch	0 dB (100%)
FILTERS	Both Off (out)
FREQUENCY	X 100, 10 (1 kHz)
F.R./L.D.	FAST RESPONSE
SIGNAL COMMON Switch	
- d. Set OSCILLATOR LEVEL at minimum (fully CCW). Measure DC voltage at (+) terminal of C7 (10 Microfarad) with respect to ground (-terminal of C15). Adjust zero trim-pot R21 for 0 Volt (± 1 mV) DC.
- e. Change INPUT switch to 1V and adjust OSCILLATOR LEVEL for exactly full scale (set level mark.)
- f. Change FUNCTION to dB VOLTS and note the exact position of meter pointer on 0 to 1 scale.
- g. Click the ADJUST control to • AUTO position.
- h. Measure DC voltage at N.C. contact of relay K1 (as shown on parts location diagram) with respect to ground (negative terminal of C15). Adjust zero trim-pot R20 for zero volts DC ± 5 mV.
- i. With INPUT switch in 1V position, adjust F.S. trim-pot R7 for the same pointer position as in step f.
- j. Change INPUT switch to 3V and adjust offset trim-pot R14 for the same pointer position as in step i.
- k. Repeat steps i and j until meter pointer rests on the same spot, $\pm 1\%$ of full-scale (\pm one line width).

OPTION 003 -
 AUTO SET LEVEL.
 AUTO SET LEVEL.
 PCB ASSY: 01700-30016

CKT REF	S-T P/N
C1-2	2100-0006
C3	2040-0000
C4	2000-0056
C6	2040-0000
C7	2100-0003
C8	2040-0000
C9	2000-0056
C11-13	2040-0000
C14	2000-0100
C15	2100-0001
C16	2100-0006
C18-19	2040-0002
C20	2040-0000
C21	2000-0056
C22-23	2040-0000
CR1-2	0200-0000
CR3 (004)	0200-0000
CR4-6	0200-0000
K1	3400-0001
K2 (004)	3400-0001
R1-3	1015-2100
R4	1015-1499
R5	1015-2133
R6 (004)	1410-0018
R7	1410-0018
R8	1015-2147
R9	1100-2270
R10	1100-2150
R11	1100-1470
R12	1100-3470
R13	1015-4100
R14	1410-0018
R15	1015-1715
R16	1015-1232
R18-19	1100-1100
R20-21	1410-0018
R22	1015-2261
R24	1100-0750
R25	1015-1100
R26	1410-0016
R27	1015-2681
R28	1015-2100
U1	0100-0010
U2-3	0100-0001
U4	0100-0015
U5	0100-0014

COMPONENT PARTS LIST
 OPT 003 - AUTO SET LEVEL

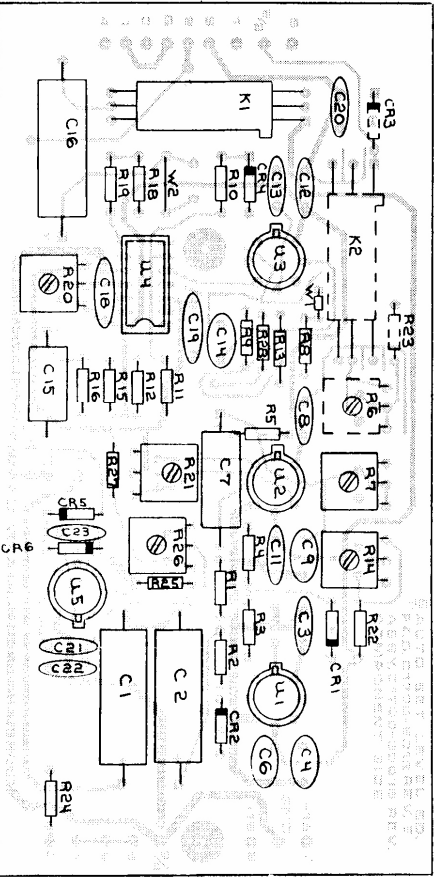
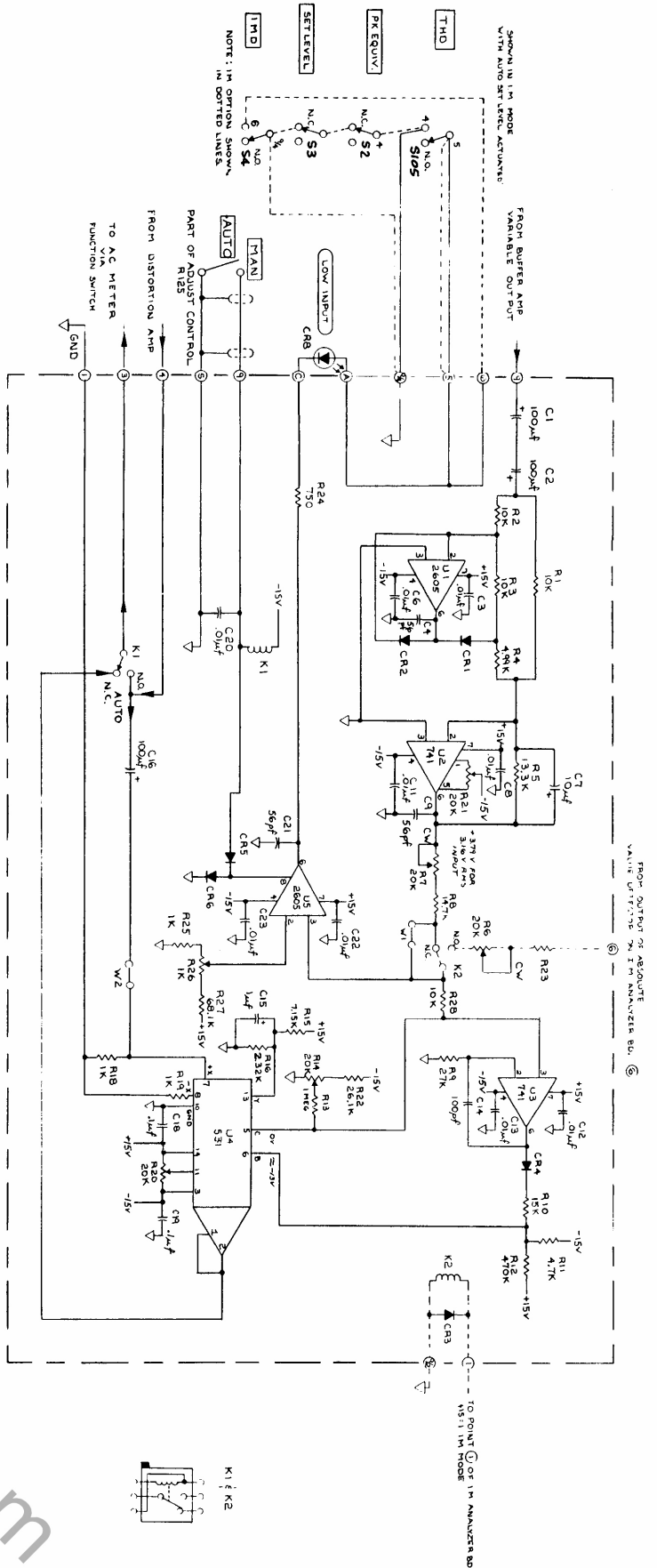
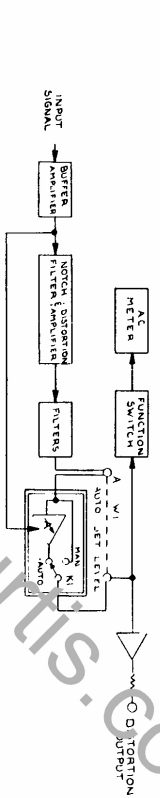

FIGURE 03-1A
 COMPONENT LOCATOR
 OPTION 003
 AUTOMATIC SET LEVEL
 (COMPOSITE ASSEMBLY -
 PARTS SHOWN MAY NOT
 BE USED ON ALL MODELS)



OPTION 004 IMD ANALYZER

SECTION I GENERAL INFORMATION

1-1. INTRODUCTION

This supplement provides operating and service information for the Model 1700B Intermodulation Distortion (IMD) Analyzer Option 004. The information contained in the supplement pertains to the IMD option only. Consult the Model 1700B manual for additional information regarding primary power requirements, grounding details, and calling instructions.

1-2. MEASUREMENT TECHNIQUE

The IMD option is based on the SMPTE (Society of Motion Picture and Television Engineers) method to measure IMD whereby a large 60-Hz signal is combined with a small 7 kHz signal in a four-to-one amplitude ratio. Passing this combined (composite) signal through a non-linear device results in the appearance of new frequencies above and below 7 kHz in multiples of 60 Hz. The effect of these new frequencies is amplitude modulation of the 7 kHz signal, which can be detected.

The component parts of the IMD option include a signal source and an IM analyzer. The signal source generates a low-frequency sinusoid and a high-frequency sinusoid that are mixed and fed to the input of the device under test. Level controls are provided so that the amplitude of the composite signal can be set to the desired level. The signal from the output of the device under test is then fed back to the analyzer circuits of the IMD meter. A high-pass filter removes the low frequency, leaving only the high frequency together with any possible low-frequency modulation. This signal is input to an envelope detector (or absolute value detector) resulting in only the rectified carrier with its amplitude varying at a low-frequency rate. A low-pass filter removes the carrier, leaving only the modulation products. The amount of these products is indicated on the meter in terms of percentage of the high-frequency signal passed through the high-pass filter.

1-3. IMD OPTION

This option adds IMD measurement capability to the Model 1700B Distortion Measurement System. It employs the IMD measurement technique described above and in addition provides the user with a number of unique operating features. These are detailed in the following paragraphs.

The IM signal source contains a 60 Hz low-frequency oscillator and a 7 kHz high-frequency oscillator. Controls on the front panel permit a rapid selection of a composite test signal having fixed low-frequency to high-frequency ratios of 4:1 or 1:1 plus a variable ratio of greater than 16:1 to 1:1. The amplitude of the test signal is controlled by an accurate 10 dB-per-step attenuator with a range of 70 dB and by a 10 dB vernier control. The amplitude of the composite test signal can be measured directly in peak equivalent rms single tone voltage or power. This parameter, specified by the Institute of High Fidelity for IMD measurements, is defined as the voltage or power level of a sine-wave signal having a peak value equal to the peak value of the composite IM test signal. The ability to make this measurement eliminates the need for meter reading conversion or matching oscilloscope waveforms.

The IMD option combines with the Model 1700B input circuits to provide the option with a differential input configuration. In operation, the IM analyzer is capable of measuring IMD at all power levels between one milliwatt and ten kilowatts across eight ohms, with a residual intermodulation distortion of less than .0025 percent (.004 percent at one milliwatt). Meter sensitivity ranges from 100 percent to .01 percent full scale. The analyzer can also measure the LF-to-HF voltage ratio of the IM test signal from (a) input to the device under test or (b) output from the device to the analyzer. When the analyzer is used with a Model 1700B fitted with Auto Set Level (Option 003) it is possible to perform IMD testing within the range of one milliwatt to ten kilowatts without adjusting the SET LEVEL control. This feature facilitates testing volume compressors/expanders and similar non-linear devices. Operation with the Auto Set Level option also permits the user to switch from Total Harmonic Distortion (THD) testing to IMD testing without having to make adjustments to compensate for the frequency response of the device under test.

SECTION II
OPERATION

2-1. CONTROLS and INDICATORS

The data sheet at the front of this supplement describes the controls and indicators on the front panel of the Model 1700B IMD option. The following provides additional explanatory information.

- a. OFF pushbutton -- Switches system measurement mode from intermodulation distortion (IMD) to total harmonic distortion (THD). System is in THD mode when pushbutton is in.
- b. PK EQUIV V/PWR pushbutton -- Selects measurement mode whereby meter displays amplitude of IM test signal in peak equivalent rms single tone voltage or power.
- c. OUTPUT ATTEN control -- Varies level of IM test signal in 10 dB steps.
- d. OUTPUT VERNIER control -- Varies level of IM test signal over a 10 dB range.

NOTE

When the IMD option is installed in the 1700B, the output signal is routed through the output attenuator and output vernier at all times, regardless of whether the instrument is in the IMD or THD mode of operation.

- e. RATIO slide switch -- Selects desired low-frequency to high-frequency amplitude ratio of composite IM test signal. Two fixed ratios (4:1 and 1:1) are available. The VAR (variable) position allows selection of a ratio variable from greater than 16:1 to 1:1 with adjacent HF AMPL control.
- f. HF AMPL control -- Adjusts LF:HF ratio of composite IM test signal when RATIO slide switch is set to VAR position. MAX setting (fully clockwise) selects a 1:1 ratio.
- g. HF ONLY pushbutton -- Turns off low-frequency oscillator. When pushbutton is in, only the high-frequency signal is present at SIGNAL OUTPUT connector.
- h. LF ONLY pushbutton -- Turn off high-frequency oscillator. When pushbutton is in, only the low-frequency signal is present at the output.
- i. SET LEVEL pushbutton -- Selects set level function whereby meter displays amplitude of reference high-frequency signal required for IMD measurement.
- j. ADJUST control -- Adjusts amplitude of reference signal for IMD measurement.
- k. ERROR indicator -- Lights during Auto Set Level (Option 003) operation when adjacent ADJUST control is incorrectly set. Correct setting is achieved by turning ADJUST control until indicator is extinguished. Light will also go out if composite input signal is either below 20% or greater than 150% of full scale.
- l. IMD pushbutton -- Selects intermodulation distortion measurement function.
- m. IM indicator -- Lights when system is in IMD measurement mode i.e., whenever PK EQUIV V/PWR, SET LEVEL, or IMD pushbutton is in and HF ONLY and LF ONLY pushbuttons are out.

2-2. OPERATING INSTRUCTIONS

2-3. TEST SET-UP

Refer to Section I of the Model 1700B manual and connect the equipment as shown in Figure 1-1. Also, read and follow the instructions given in paragraphs 1-6 through 1-9 of the same manual before making any IMD measurements. Sync the test oscilloscope to the line frequency and set sweep speed to 5 msec/div.

2-4. IM DISTORTION MEASUREMENT WITH 4:1 or 1:1 LF:HF AMPLITUDE RATIO.

To measure intermodulation distortion with a 4:1 LF:HF composite signal, proceed as follows:

- a. Set Model 1700B ADJUST control to CAL position or AUTO (for auto set level).
- b. Set IM RATIO switch to 4:1.
- c. Press PK EQUIV V/PWR pushbutton.

- d. Ensure that HF ONLY and LF ONLY pushbuttons are in the out position.
- e. Set Model 1700B INPUT switch to desired range setting. Adjust OUTPUT ATTEN switch and OUTPUT VERNIER control for desired rms peak equivalent single tone voltage/power reading. Ensure that meter indication is in upper two-thirds of scale.
- f. Push IM SET LEVEL pushbutton and turn adjacent ADJUST control until meter reads full scale. Omit this step if using auto set level. (See Section 2-6)
- g. Push IMD pushbutton. Adjust Model 1700 B RATIO switch until meter deflection is in upper two-thirds of scale, if possible.
- h. Read distortion in either percent or dB as indicated by meter deflection and RATIO switch range setting. For example, if meter reads .67 and RATIO range is 0.1 PERCENT, distortion reading is .067%.
- i. To switch the 1700 to the THD mode, push the OFF pushbutton on the IM panel.

NOTE

It is normal for the 1700B oscillator to go through a few cycles of stabilization when switching from the IMD mode to the THD mode. This is due to the power supply for the main oscillator being turned off when in the IMD mode.

To make an IM distortion reading with a 1:1 LF:HF signal, set the IM RATIO switch to 1:1 and then carry out steps c through i above. Signal output level will increase about 55% when switching from 4:1 to 1:1.

2-5. IM DISTORTION MEASUREMENT WITH NON-STANDARD LF:HF RATIO

To perform an IM distortion measurement using a LF:HF amplitude ratio other than 4:1 or 1:1, proceed as follows:

- a. Set Model 1700 B ADJUST control to CAL position or AUTO (for auto set level).
- b. Set IMD option controls as follows:

PK EQUIV V/PWR pushbutton	-----	IN
IM RATIO switch	-----	VAR
LF ONLY pushbutton	-----	IN
HF ONLY pushbutton	-----	OUT
ANALYZER SELECT	-----	INPUT or GENERATOR OUTPUT AS DESIRED
- c. Adjust Model 1700B INPUT switch, and OUTPUT ATTEN and OUTPUT VERNIER controls for a full-scale reading on an appropriate meter voltage scale.
- d. Calculate inverse of desired LF:HF ratio. For example if desired ratios is 16:1, inverse would be 1:0.0625, LF:HF.
- e. Set LF ONLY button to out position and press HF ONLY pushbutton. Now adjust HF AMPL control until meter indicates relative high-frequency level determined in step d. For example, for a 16:1 ratio, the HF AMPL control should be adjusted to obtain a meter reading of .0625 of full scale. The INPUT switch can be stepped down to obtain a more accurate reading of the high-frequency signal. For the 16:1 ratio, the INPUT switch can be stepped down two positions, adjusting the meter reading to .625 on the 0-1.0 meter scale.
- f. Now set HF ONLY pushbutton to out position and follow steps c through i of paragraph 2-4.

2-6. IM DISTORTION MEASUREMENTS WITH AUTO SET LEVEL SET

To make an IM distortion measurement using a Model 1700 B fitted with the Auto Set Level option proceed as follows:

- a. Turn Model 1700B ADJUST control fully counter-clockwise past CAL position until detent position is reached. This activates the Auto Set Level circuit. The gain of the intermodulation analyzer must be within a certain range for the Auto Set Level to function correctly. The ERROR indicator lights whenever the intermodulation analyzer gain is not within the necessary gain "window". In this event, turn the IM ADJUST control until the ERROR indicator is extinguished. For a further explanation of this see section 3-3.
- b. Follow steps described in paragraphs 2-4 and 2-5.
- c. Observe ERROR indicator; rotate IM ADJUST control until an off "window" is found; then set the IM ADJUST control to the window's approximate center.
- d. To switch the 1700B to the THD mode, push the OFF pushbutton on the IM panel. (It is normal for the 1700B oscillator to go through a few cycles of stabilization when switching from the IMD mode to the THD mode.)

SECTION III PRINCIPLES OF OPERATION

3-1. INTRODUCTION

This section contains a functional description of the IM signal source and the IM analyzer - the principle components of the IMD option. For a description of the IMD measurement technique employed by the option and a description of its operating features, refer to Section I of this supplement.

3-2. IM SIGNAL SOURCE

Refer to the schematic diagram in Section VI of this manual. The IM signal source consists of two Wien bridge RC oscillators, a summing amplifier, and an output attenuator. The low-frequency (LF) oscillator operates at 60 Hz and is synced to the line frequency. The oscillator has an output amplitude of 6.3 volts rms (nominal). The high-frequency (HF) oscillator operates at 7 kHz and also has an output of 6.3 volts rms (nominal). The HF oscillator is optimized for maximum amplitude stability. The signals from both oscillators are coupled to the input of a summing amplifier that supplies the composite IM test signal.

The amplitude ratio of the two frequencies is controlled by varying the amplitude of the HF signal input to the summing amplifier. When the front-panel RATIO slide switch is set to the 1:1 position, the full 6.3 volts rms (nominal) HF signal is delivered to the summing amplifier. When the RATIO slide switch is set to the 4:1 position, a resistive divider attenuates the HF signal by a factor of four, so that the HF level at the summing amplifier output is one-quarter that of the LF level. When the RATIO switch is set to VAR position, a potentiometer controlled by the front-panel HF AMPL knob permits the level of the HF input to the summing amplifier to be set to any level between zero and 6.3 volts rms.

The IM signal source is operable only when the IMD switch is set to the IM (out) position. This disconnects dc operating voltage from THD low-distortion oscillator and allows the 60-Hz and 7 kHz oscillators to turn on. When the IMD OFF switch is pressed, dc power is connected to the THD low-distortion oscillator and at the same time dc voltages are applied to the two IM oscillator circuits biasing them to an off state.

The output attenuator consists of a ladder-type step attenuator in series with a 10-dB "L" attenuator. The ladder section has attenuation steps of 0, 20, 40 and 60dB, changing at every second setting of the front-panel OUTPUT ATTEN switch. Thus, the attenuation of the ladder section is 0 dB for the 0-dB and 10-dB switch settings, 20 dB for the 20-dB and 30-dB settings etc. The 10-dB "L" section is bypassed on the 0-, 20-, 40-, and 60-dB switch settings and connected in series with the ladder section on the 10-, 30-, 50-, and 70-dB settings. This provides the output attenuator with a range of 0 dB to 70 dB in 10-dB steps. The attenuator has a constant output impedance of 600 ohms.

3-3. IM ANALYZER

The following is a discussion of the IM analyzer board and Model 1700B circuits that comprise the IM analyzer. Refer to the schematic diagrams in the Model 1700B manual and Section VI of this manual for circuit details.

The IM test signal from the device under test is connected via the Model 1700B INPUT terminals to the INPUT attenuator and from there to the differential input buffer and differential-to-single-ended buffer. The output signal from the buffer amplifier (in the range of 1 to 3.16 peak equivalent volts), is coupled via a passive 2-pole high-pass filter to the input buffer. The filter attenuates the 60Hz component of the IM signal by approximately 26 dB. The gain of the input buffer is variable from 2 to 100 by the front panel IM ADJUST control. This allows the amplitude of the signal at the output of the IM buffer (TP1) to be set to approximately 3.16 volts, the correct set level for the IM distortion measurement.

From the IM input buffer, the signal is connected to an active 7-pole, high-pass filter having a cut-off frequency of 2kHz. This attenuates the 60 Hz by a further 210 dB, leaving only a pure 7 kHz sine wave plus any amplitude modulation caused by the non-linearity of the device under test. From here, the signal is connected to an absolute value detector that rectifies the 7 kHz waveform.

When the IM SET LEVEL pushbutton is pressed the output of the absolute value detector, which is essentially a dc level representing the amplitude of the 7 kHz component of the test waveform, is connected through switch S3 to the front panel meter. This permits monitoring the amplitude of the HF component of the input signal for Set-Level adjustments.

The output of the absolute value detector is also coupled to a 7-pole, low-pass filter with a cut-off frequency of 500 Hz. This removes the 7 kHz component from the rectified signal, leaving only the intermodulation products. The output from the low-pass filter is connected to the THD RATIO attenuator and distortion amplifier through OFF switch, S1. The amplifier output is 31.6 mV full scale for each attenuator setting.

An IM measurement is made by pressing the IMD pushbutton, connecting the distortion amplifier output via the auto set level option and the IM meter amplifier to the front panel meter. If the auto set level option is not fitted, the signal is jumpered directly from the distortion amplifier to the IM meter amplifier. Also, when the system is in the IM measurement mode, a relay bypasses the 400 Hz and 80 kHz filters located between the distortion amplifier output and the input of the auto set level circuit. This relay is on the THD analyzer board and activated through a contact on relay K1, located on the IM analyzer board.

When the PK EQUIV V/PWR pushbutton switch S2 is pressed, the output of the THD meter preamplifier is connected via the IM peak detector to the front-panel meter. The THD meter preamplifier has a 31.6 mV full scale output on each range of the INPUT attenuator and the peak detector buffer has a gain of approximately 22. This changes the 31.6 mV full scale signal to approximately one volt peak at the peak detector input and causes one milliampere of current to be supplied to the meter for a full scale reading.

The peak detector, consisting of U9 and associated components, operates as a summing amplifier. The input to the circuit may be considered to be at the junction of capacitor C46 and resistor R36. The detector responds to negative input peaks. Meter current (average one milliampere full-scale) flows back to the summing point through resistor R38. If the peak negative input current through R36 exceeds the feedback current, the output of U9 will go positive and add charge to C55 through emitter-follower Q1. This added charge will then increase the average meter current: As long as the output of U9 swings positive each cycle, Q2 will conduct each cycle, thus holding down the voltage on C54 and preventing Q3 from conducting. If the peak input current does not exceed the feedback current, the output of U9 remains clamped negative by diode CR5 at approximately 0.7 volts. In this event, the voltage on C54 will rise, and Q3 will conduct to quickly reduce the charge on C55. This allows the meter to respond quickly to a decreasing signal level.

The Auto Set Level option provides automatically controlled gain at the output of the distortion amplifier to compensate for a 10 dB range of input signal. For THD measurements, gain is simply controlled by the input signal level, which is the reference for the measurement. For IMD measurements, the reference for the measurement is not the input signal (total composite signal) but rather the level of the high-frequency (7 kHz) component. Yet, the input signal level indicated on the front panel meter (pk equiv v/pwr) during the measurement is proportional to the peak value of the composite signal.

For the Auto Set Level to operate over a 10 dB range of peak equivalent volt/power level, it is necessary that the SET LEVEL control be adjusted such that when in the SET LEVEL mode, the meter reads within approximately plus or minus 2 dB of the meter deflection when in the PK EQUIV V/PWR mode. This places the output of the absolute level detector in the proper range to control the auto set level circuit. Once the SET LEVEL control is properly set, no further adjustment is required unless the low-to-high frequency ratio at the analyzer input is changed. Now, the 7 kHz level (absolute value detector output) tracks the input signal level (peak detector output).

In order to avoid possible readout error due to an incorrectly adjusted SET LEVEL control, a "window" detector is incorporated in the IM analyzer. This circuit consists primarily of operational amplifiers U14 and U15. U14 turns on ADJUST light-emitting diode CR24 if the output of the absolute value detector, as divided down by resistors R68, R70 and R71, exceeds the output of the peak detector by approximately 2.5 dB. The peak

detector output is derived from the voltage developed across resistor R38. Conversely, U15 turns on the ADJUST indicator if the output of the peak detector exceeds the output of the absolute value detector, as divided down and appearing at pin 3 of U15, by approximately 2 dB.

Operational amplifiers U16 and U17 act in a similar manner to disable the ADJUST indicator (by absorbing the drive current through R79) if the peak equivalent volt power reading is much too low (less than 20 percent of full scale), or too high (greater than 150 percent of full scale). Here the peak detector output is simply compared to dc levels. Q4 is used to turn off the ADJUST indicator when the instrument is not in the auto mode of operation. If the auto set-level option is not installed, R79 is removed.

The reader may be interested to know that in the U17/U18 comparator circuit, diode CR22 is a redundant component. If the output of U17 goes negative, it pulls the output of U16 negative through the pin 8 connections. Therefore CR22 may be used as a spare diode.

SECTION IV MAINTENANCE

4-1. INTRODUCTION

This section provides a performance check, adjustment and calibration procedures, and troubleshooting information for the IMD option.

4-2. TEST EQUIPMENT

Recommended test equipment for performance checking and troubleshooting is listed in Table 4-1. Test instruments other than those described can be used provided their specifications equal or exceed those listed.

Table 4-1. Required Test Equipment

TYPE	REQUIRED SPECIFICATIONS	USE	RECOMMENDED INSTRUMENT
AC-DC DIGITAL VOLTMETER	Range: 1mV to 2V Accuracy: 0.1% ± 1 digit	Calibration	Fluke Model 8000A
Audio Generator	Frequency Range: to 8 kHz	Calibration	Sound Technology Model 1700 B or 1400A
OSCILLOSCOPE	Bandwidth: 500 kHz Deflection Factor: 5 mV/div Number of Channels: 2	Calibration and Troubleshooting	Hewlett-Packard Model 1200A or Philips Model 3232

4-3. PERFORMANCE CHECK

4-4. INTRODUCTION

The performance check for the IMD option consists of an intermodulation residual distortion test. If the performance limits are exceeded in the following paragraph, refer to the troubleshooting hints in paragraph 4-16.

4-5. INTERMODULATION RESIDUAL DISTORTION TEST

- a. Connect equipment in test configuration shown in Figure 1-1 of Model 1700B manual except connect a cable from SIGNAL OUTPUT/GENERATOR OUTPUT connector of Model 1700B directly to its INPUT terminals. Set Model 1700B ADJUST control to CAL position.

b. Set IMD option controls as follows:

IM RATIO switch -----4:1
HF ONLY pushbutton -----out
LF ONLY pushbutton -----out
OUTPUT ATTEN switch -----0 dB
OUTPUT VERNIER control -----max CW

- c. Press PK EQUIV V/PWR pushbutton and set INPUT switch to 3 VOLTS range.
d. Press IMD SET LEVEL pushbutton and rotate adjacent ADJUST control for a full-scale reading on meter.
e. Press IMD pushbutton and set RATIO switch to -80 dB/.01 PERCENT range. Check that meter reading is .0025% or less.

4-6. ADJUSTMENT AND CALIBRATION PROCEDURE

This procedure should be performed whenever the results of the performance check (Paragraph 4-3) clearly establish the need to do so. After successfully performing in sequence the procedure in Paragraphs 4-7 through 4-15, the IMD option is considered to be calibrated.

NOTE

When performing this procedure ensure that only the equipment and cables specified are connected to the instrument.

4-7. IM GENERATOR

4-8. OSCILLATOR ADJUSTMENTS

a. Set front panel controls as follows:

PK EQUIV V/PWR pushbutton -----in
HF ONLY pushbutton -----out
LF ONLY pushbutton -----in
RATIO switch -----1:1
OUTPUT VERNIER -----max CW
OUTPUT ATTEN switch -----0dB
FAST RESPONSE/LOW DISTORTION switch -----Fast Response
THD ADJUST control -----CAL

(Ignore an indicated overload condition) Remove sync from LF oscillator either by removing connection to power transformer (#7 on Generator Board) or by lifting one end of C19. Connect SIGNAL OUTPUT to a scope with horizontal sweep (5 ms/cm) synced to power line. Adjust R4 for a stationary pattern (LF oscillator running at line frequency). It may be necessary to adjust FET bias (R8) to keep oscillator running as R4 is adjusted. Restore LF osc. sync.

b. Connect a cable between SIGNAL OUTPUT connector and INPUT terminals.

LF ONLY pushbutton -----out

- c. Measure Q6 gate voltage (an easy place to measure is at C11, .033 uf.). Allowable range is 1.0 to 2.0 Vdc. If out of range, adjust R23 for a reading 1.5 Vdc. Isolate gate voltage from voltmeter probe with a 10 K ohm resistor.
- d. Measure Q3 gate voltage (an easy place to measure is at collector of Q2. Don't forget 10 K isolation!). Allowable range is 1.0 to 2.0 Vdc. If out of range, adjust R8 for a reading of 1.5 Vdc.
- e. Press HF ONLY pushbutton. Adjust OUTPUT VERNIER control until front panel meter reads exactly full scale.

f. Change front panel controls as follows:

HF ONLY pushbutton -----out
LF ONLY pushbutton -----in

g. Without changing setting of OUTPUT VERNIER control, carefully adjust R13 until front panel meter indicates same full-scale reading obtained in Step C above.

h. Repeat Step d above. If it was necessary to readjust R8, repeat Step g.

4-9. 4:1 DIVIDER CONFIDENCE CHECK

a. Change front panel controls as follows:

INPUT switch -----3V
RATIO switch -----4:1

b. Adjust OUTPUT VERNIER (and/or R44) for a front panel meter reading as close as possible to 2.40 Vac.

c. Change front panel controls as follows:

HF ONLY pushbutton -----in
LF ONLY pushbutton -----out
INPUT switch -----1 V

d. Check that front panel meter reads $0.60 \pm .02$ V.

4-10. IM ANALYZER

4-11. PEAK DETECTOR AND THD SIGNAL LEVEL ADJUSTMENTS

a. Connect DVM in parallel with cable connected between SIGNAL OUTPUT connector and INPUT terminals.

b. Change front panel controls as follows:

HF ONLY pushbutton -----out
LF ONLY pushbutton -----in

c. Adjust OUTPUT VERNIER and OUTPUT ATTEN controls (and/or R44) for DVM reading of 0.800 Vac.

d. Change front panel controls as follows:

HF ONLY pushbutton -----out
LF ONLY pushbutton -----out

e. Adjust R34 on IM analyzer board for an exact full-scale reading on front panel meter.

f. Change front panel controls as follows:

INPUT switch -----3V
OUTPUT ATTEN switch -----0 dB
OUTPUT VERNIER -----max CW

g. Adjust R44 (IM generator board) for a full-scale reading on front panel meter.

4-12. ABSOLUTE VALUE DETECTOR OFFSET NULL

a. Remove input signal and set INPUT switch to 3V.

- b. Connect DVM between TP4 and ground (negative end of C34).
- c. Set DVM to its most sensitive range.
- d. Adjust R22 for DVM reading of less than $\pm .003\text{Vdc}$.

4-13. IMD MEASUREMENT CALIBRATION

- a. Connect a cable between SIGNAL OUTPUT and the INPUT terminals with the high side of the SIGNAL OUTPUT connected to the + INPUT terminal.
- b. Connect a 47 kilohm resistor to the + INPUT terminal.
- c. Connect an external audio oscillator between the -INPUT terminal and the floating end of the 47 kilohm resistor.
- d. Set front panel controls as follows:

```

PK EQUIV V/PWR -----in
RATIO -----1:1
HF ONLY -----in
LF ONLY -----out
OUTPUT ATTEN -----0dB
INPUT -----1 Volt Range
RATIO -----40dB(1%)
THD ADJUST -----CAL

```

- e. Connect vertical input of oscilloscope to DISTORTION OUTPUT. Set controls as follows:

```

Vertical Sensitivity -----20 mV/cm
Sweep -----5 ms/cm
Sync -----Internal

```

- f. Set external audio oscillator frequency to approximately 7 kHz.
- g. With output of external oscillator reduced to zero, adjust OUTPUT VERNIER for 1700B meter reading as close to exact full scale as possible.
- h. Change front panel controls as follows:

```

OUTPUT ATTEN -----70 dB
LF ONLY -----in
INPUT -----.01 volt range

```

Adjust output of external oscillator for a meter reading as close to exact full scale as possible.

- i. Change front panel controls as follows:

```

LF ONLY -----out
OUTPUT ATTEN -----0dB
INPUT -----3 Volt range

```

Adjust the frequency of the external oscillator for a 10 to 15 ms period of the sinc wave appearing on the scope.

Adjust IM SET LEVEL control for an exact full scale reading on the meter.

- j. Depress IMD pushbutton. Adjust R63 on the IM Analyzer board for an exact full scale reading.

4-14. AUTO SET LEVEL ADJUSTMENT

- a. Turn THD ADJUST control to AUTO position. Adjust R6 on the auto set level board for an exact full-scale (1.00%) reading.
- b. Switch INPUT switch to 10 volt range. Check that reading is $1.00 \pm .02\%$.

4-15. TROUBLESHOOTING

Before attempting to troubleshoot the IMD Option ensure that the fault is with the option and not caused by the test setup or associated equipment. The performance check (Paragraph 4-3) enables this to be determined without having to remove the covers.

If an abnormal condition is observed during the performance check, table 4-2 will suggest remedies. However, before proceeding with detailed troubleshooting, note the troubleshooting hints contained in paragraph 3-29 of the Model 1700B Manual.

4-16. SYMPTOM/CAUSE TABLE

Table 4-2 contains symptoms of IMD option malfunctions and provides diagnostic tests for the location of these faults. Following the repair of a defective component, refer to paragraph 4-1 for instructions regarding any necessary calibration and/or adjustment procedures.

Table 4-2. IMD Symptom-Cause Table

Symptom	Probable Cause	Diagnostic Test
Abnormally high level of residual IM distortion, distortion product is random noise.	7 kHz oscillator amplitude instability, Q6 gate voltage out of adjustment.	Measure dc level at gate of Q6 on IM analyzer board. Reading should be between 1.0 and 2.0 Vdc.
Abnormally high level of residual IM distortion, distortion product is multiple of 60-Hz	(1) Nonlinearity in IM generator summing amplifier U3, IM analyzer buffer U1. (2) Nonlinearity in THD buffers U101, U102, U103.	(1) Replace U3, U1. (2) Replace U101, U102, U103
Amplitude of 60-Hz oscillator is unstable, or oscillator is not synced to line.	Q3 gate voltage out of adjustment.	Measure dc level of gate of Q3 on IM generator board. Reading should be between 1.0 and 2.0 Vdc. Check freq. adjustment per 4-8a.

4-17. COMPONENT REPLACEMENT - CALIBRATION AND ADJUSTMENT

If U1 or U2 in the generator section are replaced, do the oscillator adjustments, section 4-8. In general, changing IC's in the analyzer section do not require re-adjustment. The exception is U6 in the Absolute Value Detector. Changing U6 would require the zero adjustment at TP4, section 4-12.

4-18. ACCESS TO LOW-DISTORTION OSCILLATOR

In order to reach the low-distortion oscillator assembly, it is necessary to move the IM analyzer board mounted above it. To reach the oscillator, proceed as follows:

- a. Remove top cover from instrument.

- b. Locate metal shield on which IM analyzer board is mounted.
- c. Remove four screws attaching this shield to instrument. Do not remove screws securing IM analyzer board to shield.
- d. Carefully move shield back until pushbuttons on board clear rear of front panel.
- e. Move shield until it is located vertically above center of instrument. Insert upper edge of instrument's center divider into slot on edge of IM analyzer shield. This holds board in a position that permits access to oscillator.
- f. Replace IM analyzer board following reverse procedure.

SECTION V
MODIFICATIONS FOR EUROPE AND JAPAN

5-1. DIN (EUROPE)

- a. The Low Frequency Oscillator is set at 250 Hz and is not synchronized with the power line. The High Frequency Oscillator is at 8 kHz. The IM measurement then conforms to DIN 45403, Page 4 - "Measurement of non-linear distortion in electroacoustics; intermodulation method", and DIN 45500, Page 6 - "Hi-Fi techniques, requirements for amplifiers".

A scope sync (250 Hz) is available at a BNC connector on the rear panel.

The Passive, High-Pass Filter has been changed to have a cut-off frequency of 3.9 kHz.

The Low-Pass Filter has been changed to have a cut-off frequency of 1.25 kHz.

- b. The following parts have been changed:

Reference Designators	Description	Stock No.	Qty.
<u>IM Analyzer Board</u>			
C1, C2	.02 uf, 1%, 33V, plystr	2025-0004	2
C3, C4	.0068 uf, 2.5%, 63V, plystr	2025-0016	2
C32	.0082 uf, 1%, 33V, plystr	2025-0002	1
C37	.082 uf, 1%, 33V, plystr	2025-0005	1
C36	.0033 uf, 2.5%, 63V, plystr	2025-0014	1
C36A	680 pf, 2.5%, 63V, plystr	2025-0019	1
R46, 47, 48, 49	5.23 K, 1%, 1/8W, MF	1015-1523	4

IM GENERATOR BOARD

C1, C2	.022 uf, 2.5%, 63V, plystr	2025-0029	2
R18, 20	10K, .25%, 1/8W, MF	1005-2100	2
R17	10K, 1%, 1/8W, MF	1015-2100	1
R16	52.3K, 1%, 1/8W, MF	1015-2523	1
R3, 5	28.7K, 1%, 1/8W, MF	1015-2287	2

- c. Also, the following changes or additions have been made:

1. Replace R4 (5K trim-pot) with a jumper.
2. Remove R2 (15K, 5%, 1/4W) from board.
3. Remove sync cable to IM generator Board (pad 7).
4. Add shielded cable between pad 5 on generator board and BNC scope sync connector on rear panel.

5-2. 50/60 Hz OPERATION (JAPAN)

The Low Frequency Oscillator is set to 60 Hz and is free-running. A scope sync is available at a BNC connector on the rear panel. Sections 5-1-C-2,3,4 above are applicable.

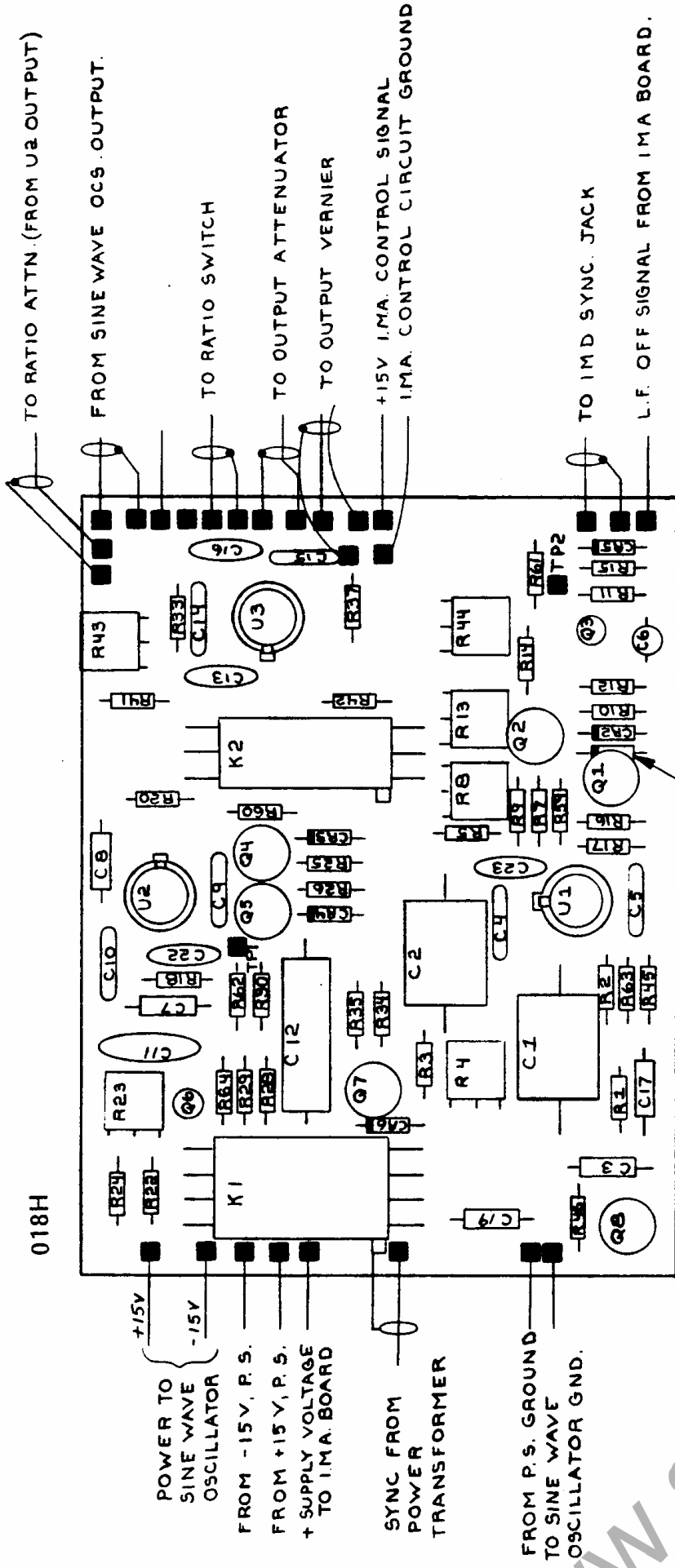

018H

+15V
-15V
POWER TO SINE WAVE OSCILLATOR
FROM -15V, P. S.
FROM +15V, P. S.
+ SUPPLY VOLTAGE TO I.M.A. BOARD

SYNC FROM POWER TRANSFORMER

FROM P.S. GROUND TO SINE WAVE OSCILLATOR GND.

COMPONENT LOCATOR
I.M. GENERATOR BOARD
MODEL 1700B

www.stancurtis.com

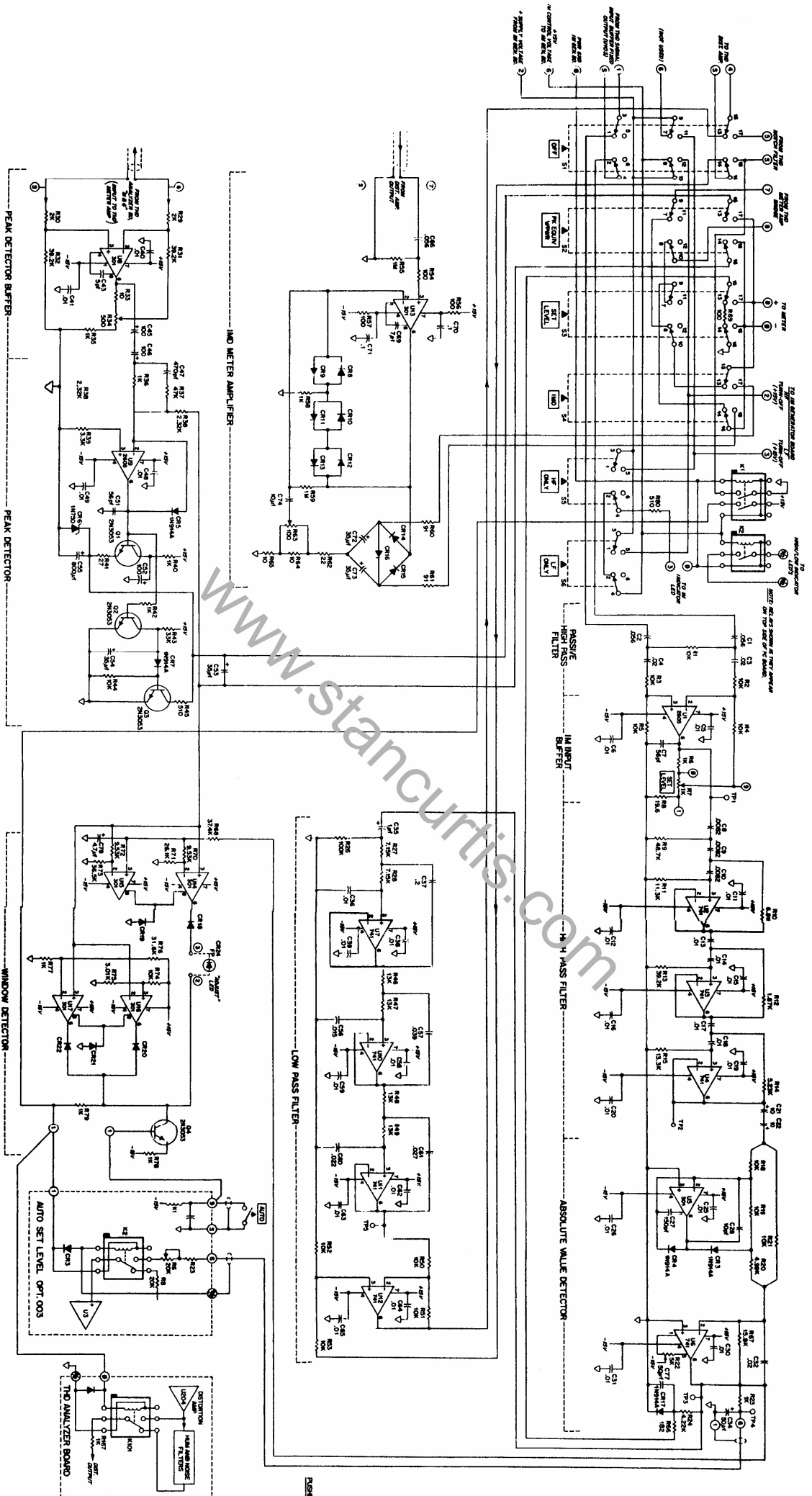

SCHEMATIC DIAGRAM
IM ANALYZER BOARD

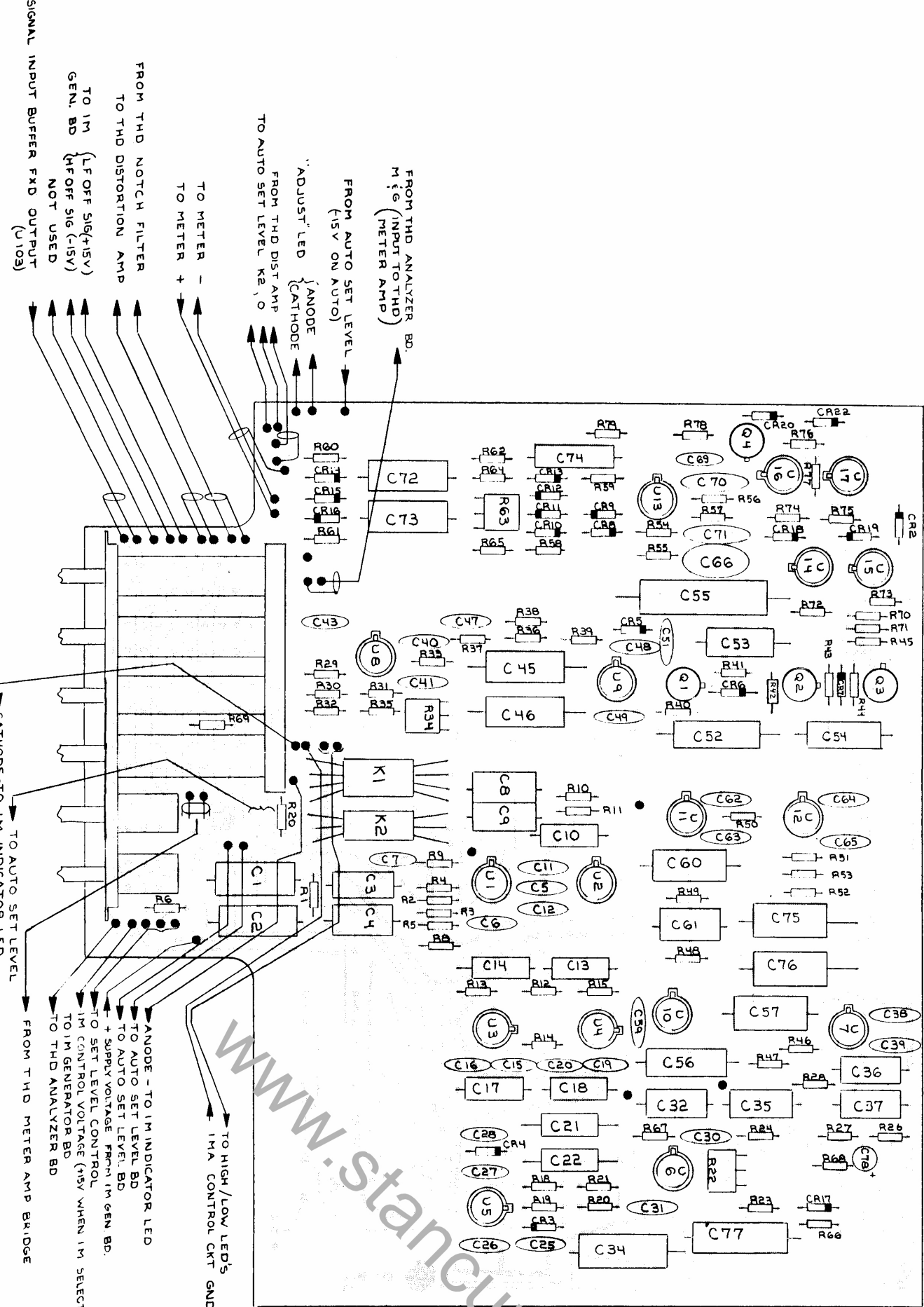

FROM THD ANALYZER BD.
MIG (INPUT TO THD METER AMP)

FROM AUTO SET LEVEL (15V ON AUTO)

"ADJUST" LED
{ ANODE
{ CATHODE

FROM THD DIST AMP
TO AUTO SET LEVEL K2, 0

TO METER -

TO METER +

FROM THD NOTCH FILTER
TO THD DISTORTION AMP

TO IM (LFOFF SIG(+15V) GEN. BD
{ HFOFF SIG(-15V) NOT USED

SIGNAL INPUT BUFFER FXD OUTPUT (U103)

CATHODE-TO IM INDICATOR LED

TO AUTO SET LEVEL

FROM THD METER AMP BRIDGE

TO HIGH/LOW LED'S
1MA CONTROL CRT GND.

ANODE - TO IM INDICATOR LED

TO AUTO SET LEVEL BD

TO AUTO SET LEVEL BD

+ SUPPLY VOLTAGE FROM IM GEN. BD.

TO SET LEVEL CONTROL

IM CONTROL VOLTAGE (15V WHEN IM SELECTED)

TO IM GENERATOR BD

COMPONENT LOCATOR
OPTION 004 - IMD ANALYZER
IM ANALYZER PCB ASSY

www.stancurtis.com

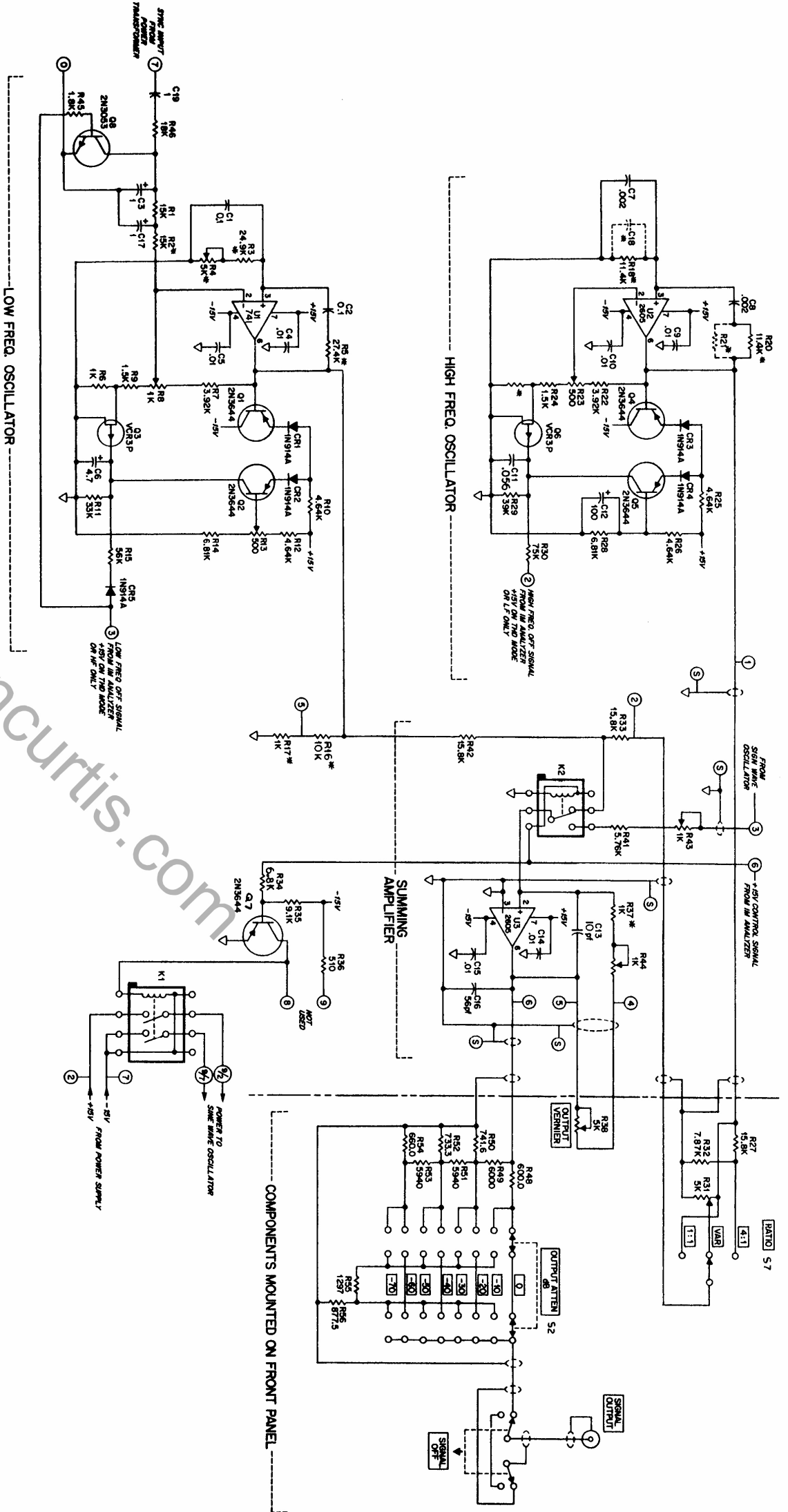

* SELECTED AT TEST, NOMINAL VALUE SHOWN. PART MAY NOT BE USED ON SOME VERSIONS.

SCHEMATIC DIAGRAM
IM GENERATOR BOARD
MODEL 1700B